

Dlaczego origami?

Jesteśmy dużą organizacją – zespołem ludzi, którzy angażując się w pracę oddają się również swoim pasjom. To, jak postrzegamy świat, jak potrafimy czerpać z niego dobre emocje przekłada się na efekty naszej pracy. Kolejna edycja katalogu KOLEKCJA 2011 to doskonała okazja do zaprezentowania Państwu naszych nowych produktów, jak i osób które biorą bezpośredni udział w ich powstawaniu.

Realizując nowe projekty staramy się łączyć design z nowoczesną technologią. Naszym celem jest pokazanie, że przedmiot może być dobrze i funkcjonalnie zaprojektowany oraz dostępny dla wszystkich. Szczególną uwagę skupiamy na uzyskaniu najwyższej jakości wykończenia detali produktów. Precyzja, dokładność i skrupulatność są szczególnie potrzebne podczas realizowania tego etapu. Jednym z elementów świadczących o wysokiej jakości naszych baterii jest ich powierzchnia – gładka i równa z atrakcyjną lustrzaną powłoką. To efekt zaawansowanej technologii nakładania powierzchni chromowanych nad którą czuwa technolog EWA MITKA – chemik z wykształcenia, miłośniczka origami, japońskiej sztuki składania papieru.

To naprawdę wielka przyjemność patrzeć, jak kawałek papieru zmienia się w piękny kwiat lub postać – jak ciężki, mosiężny odlew zmienia się w błyszczącą, funkcjonalną baterię łazienkową.

Zachęcamy do przygody z origami – odrobina wyobraźni przestrzennej, fantazji i zręczności pozwoli Państwu z kwadratowego arkusza papieru, bez pomocy nożyczek, kleju, farb stworzyć wesołą postać konika morskiego.

Armaturn®
GRUPA ARMATURA

Armatura sanitarna



Armatura wodna i gazowa



Grzejniki i armatura
centralnego ogrzewania



- Premium Class
- Royal Class
- Middle Class
- Basic Class
- Baterie specjalne
- Natryski
- Akcesoria



s. 08 – 99

- Zawory wypływowe
- Zawory kątowe
- Zawory kulowe
- Zawory gazowe
- Przyłącza do gazu

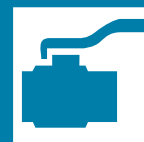

s. 100 – 119

- Grzejniki aluminiowe
- Armatura centralnego ogrzewania
- Elementy złączne



s. 120 – 133



Zapraszamy na naszą stronę www.grupa-armatura.pl – przyjazna struktura serwisu opracowana na bazie wyników badań przeprowadzonych z naszymi użytkownikami; atrakcyjna szata graficzna oddająca unikalny charakter produktów; zaawansowane wyszukiwanie skracające czas potrzebny na dotarcie do informacji.

www.grupa-armatura.pl

Armatura sanitarna



Armatura wodna i gazowa



Grzejniki i armatura
centralnego ogrzewania



- Premium Class 12
- Royal Class 40
- Middle Class 46
- Basic Class 68
- Baterie specjalne 78
- Natryski 82
- Akcesoria 96



s. 08 – 99



KOŁO

Sesję zdjęciową zrealizowano
w Salonie Koło w Modniczce
k. Krakowa





Premium Class

Kolekcja PREMIUM CLASS została stworzona specjalnie dla odbiorcy szukającego oryginalnych i wyrafinowanych rozwiązań do swojego domu. Elegancka forma, wysoka jakość wykonania i funkcjonalność, to największe atuty kolekcji. PREMIUM CLASS to optymalne połączenie jakości, niezawodności i wyszukanego wzornictwa. Prawdziwy klejnot w Państwa łazience oraz kuchni.

PREMIUM CLASS has been created especially for clients looking for original and sophisticated solutions in his home. Elegant form, top quality finish and functionality are the main features of the collection. PREMIUM CLASS is an optimal combination of quality, reliability and sophisticated design. A real jewel in ones bathroom and kitchen.

Premium Class

ametyst
brylant – new
cyrkon
cyrkon decorum
diament – new
jantar
korund – new
kwarc
malachit – new
rubin
baterie termostatyczne exclusive
mixers with termostat exclusive
baterie kuchenne
kitchen mixers



Premium Class | Brylant

[4303-615-00]

Bateria umywalkowa stojąca
Single hole wash basin mixer
Смеситель для умывальника
Einloch Waschtischeinhebelmischer







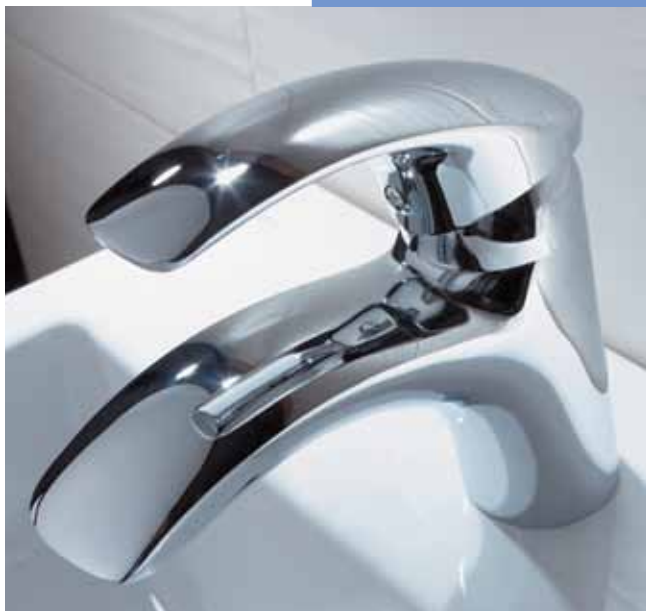

















baterie jednouchwytowe AMETYST

single lever mixers AMETYST



Rodzina AMETYST to propozycja dla najbardziej wymagających Klientów. Doskonała, okazała forma harmonijnie łączy ze sobą elegancję i funkcjonalność. Elitarnego charakteru nadaje jej trójotworowa bateria wannowa idealnie pasująca do eleganckich, wyrafinowanych łazienek.

The AMETYST family is an offer for the most demanding clients. An excellent, impressive form harmoniously combines elegance and functionality. An exclusive character gives it the three function bathtub mixer ideally suitable for elegant, sophisticated bathrooms.

  <p>[404-010-00]</p> <p>Bateria wannowa ścienna Bath mixer Смеситель для ванны Aufputz Wannenfüll- und Brauseeinhebelmischer ohne Duschset</p>	  <p>[405-210-00]</p> <p>Bateria wannowa trójotworowa stojąca Three-hole bath mixer Стойкий смеситель для ванны в трех отверстиях Dreiloch Wannenfülleinhebelmischer</p>	  <p>[406-010-00]</p> <p>Bateria natryskowa ścienna Shower mixer Смеситель для душа Aufputz Brauseeinhebelmischer ohne Duschset</p>	  <p>[409-410-00]</p> <p>Bateria wannowa podtynkowa z przyłączem do zestawu natryskowego (element sterujący) Built-in bath mixer Смеситель для ванны скрытого монтажа Unterputz Wannenfülleinhebelmischer</p>
  <p>[836-001-00]</p> <p>Wylot do baterii wannowej podtynkowej Outlet Вылет воды для смесителя скрытого монтажа Ausguss</p>	  <p>[409-610-00]</p> <p>Bateria natryskowa podtynkowa (element sterujący) Built-in shower mixer Смеситель для душа скрытого монтажа Unterputz Brauseeinhebelmischer</p>	  <p>[845-100-00]</p> <p>Dysk natryskowy z ramieniem L=380 mm Shower disk L=380 mm Душевой диск L=380 mm Duschteller L=380 mm</p>	  <p>[845-101-00]</p> <p>Głowica natryskowa z ramieniem L=280 mm Shower head L=280 mm Душевая головка L=280 mm Duschkopf L=280 mm</p>
  <p>[402-815-00]</p> <p>Bateria umywalkowa stojąca Single hole wash basin mixer Смеситель для умывальника Einloch Waschtischeinhebelmischer</p>	  <p>[407-015-00]</p> <p>Bateria bidetowa stojąca Bidet mixer Смеситель для биде Einloch Bideteinhebelmischer</p>	  <p>[403-110-00]</p> <p>Bateria zlewozmywakowa stojąca z wyciąganym natryskiem L=205 mm Single hole sink mixer with handshower Смеситель с выдвижным душем Einloch Spültischeinhebelmischer mit Handbrause</p>	  <p>[403-915-00]</p> <p>Bateria zlewozmywakowa stojąca z obrotowym wylotem L=230 mm Single hole sink mixer Смеситель для мойки с поворотным изливом Einloch Spültischeinhebelmischer</p>



Nowość

baterie jednouchwytowe BRYLANT















single lever mixers BRYLANT



Baterie BRYLANT to produkt dla prawdziwych koneserów. Efekt umiejętnego połączenia technologii, funkcjonalności, a także konsekwencji i odwagi stylistycznej. Zdecydowane linie, asymetryczna konstrukcja w najwyższej jakości oraz precyzja wykonania – wszystko zamknięte w doskonałej modernistycznej formie.

BRYLANT mixers – products for real connoisseurs. The effect of a skilful combination of technology and functionality and also consequence and stylistic bravery. Firm lines, asymmetric top quality construction and precision. All closed in an excellent modern form.



  [4304-010-00] Bateria wannowa ścienna Bath mixer Смеситель для ванны Brauseeinhebelmischer ohne Duschset	  [4306-010-00] Bateria natryskowa ścienna Shower mixer Смеситель для душа Aufputz Brauseeinhebelmischer ohne Duschset	  [4302-612-00] Bateria umywalkowa stojąca nablutowa Single hole wash basin mixer Смеситель для свободностоящих раковин Einloch Waschtischeinhebelmischer	  [4302-712-00] Bateria umywalkowa stojąca nablutowa Single hole wash basin mixer Смеситель для свободностоящих раковин Einloch Waschtischeinhebelmischer
  [4302-811-00] Bateria umywalkowa stojąca z zaworami kątowymi Single hole wash basin mixer Смеситель для умывальника Einloch Waschtischeinhebelmischer	  [4303-615-00] Bateria umywalkowa stojąca Single hole wash basin mixer Смеситель для мойки и умывальника Einloch Waschtischeinhebelmischer	  [4303-715-00] Bateria umywalkowa stojąca Single hole wash basin mixer Смеситель для мойки Einloch Waschtischeinhebelmischer	  [4307-011-00] Bateria bidetowa z zaworami kątowymi Bidet mixer Смеситель для биде Einloch Bideteinhebelmischer





baterie jednouchwytowe

CYRKON



























single lever mixers CYRKON











Jedna z najbogatszych rodzin w ofercie Armatury Kraków. Przykład klasycznej elegancji opartej na cylindrycznych kształtach, gdzie łagodne łuki, smukła linia i ostre krawędzie podkreślają jej szlachetny charakter. Rodzina CYRKON jest dostępna z oryginalnym uchwytem w wersji chromowanej i satynowej. Niekonwencjonalne rozwiązanie w postaci bocznego umieszczenia regulatora w stojących bateriach umywalkowych i zlewozmywakowych nadaje im dodatkowych walorów funkcjonalnych.

One of the widest collections in the Armatura Kraków range. The model of classic elegance based on cylindrical shapes where soft arches, slim line and sharp edges underline its noble character. The CYRKON collection is available with an original handle in a chrome and satin version. Unconventional solution in the form of a side position of regulation in standing wash-basin and sink mixers gives it additional values with regards to functionality.

N O M I N A C J A
P R O D E C O 2007

  <p>[584-010-00] uchwyt chrom [584-020-00] uchwyt chrom-satyna</p> <p>Bateria wannowa ścienna Bath mixer Смеситель для ванны Brauseeinhebelmischer ohne Duschset</p>	  <p>[585-210-00] uchwyt chrom [585-220-00] uchwyt chrom-satyna</p> <p>Bateria wannowa trójotworowa stojąca Three-hole bath mixer Стойкий смеситель для ванны в трех отверстиях Dreiloch Wannenfülleinhebelmischer</p>	  <p>[586-010-00] uchwyt chrom [586-020-00] uchwyt chrom-satyna</p> <p>Bateria natryskowa ścienna Shower mixer Смеситель для душа Aufputz Brauseeinhebelmischer ohne Duschset</p>	  <p>[589-410-00] uchwyt chrom [589-420-00] uchwyt chrom-satyna</p> <p>Bateria wannowa podtynkowa z przyłączem do zestawu natryskowego (element sterujący) Built-in bath mixer Смеситель для ванны скрытого монтажа Unterputz Wannenfülleinhebelmischer</p>
  <p>[836-001-00]</p> <p>Wylot do baterii wannowej podtynkowej Outlet Вылет воды для смесителя скрытого монтажа Ausguss</p>	  <p>[589-610-00] uchwyt chrom [589-620-00] uchwyt chrom-satyna</p> <p>Bateria natryskowa podtynkowa (element sterujący) Built-in shower mixer Смеситель для душа скрытого монтажа Unterputz Brauseeinhebelmischer</p>	  <p>[845-100-00]</p> <p>Dysk natryskowy z ramieniem L=380 mm Shower disk L=380 mm Душевой диск L=380 mm Duschteller L=380 mm</p>	  <p>[845-101-00]</p> <p>Głowica natryskowa z ramieniem L=280mm Shower head L=280 mm Душевая головка L=280 mm Duschkopf L=280 mm</p>
   <p>[580-810-00 / 580-910-00] uchwyt chrom [580-820-00 / 580-920-00] uchwyt chrom-satyna</p> <p>Bateria umywalkowa / zlewozmywakowa ścienna L=150 mm / 200 mm Wash basin mixer / sink mixer Смеситель для мойки и умывальника Aufputz Wasch- und Spültischeinhebelmischer</p>	  <p>[582-815-00] uchwyt chrom [582-825-00] uchwyt chrom-satyna</p> <p>Bateria umywalkowa stojąca Single hole wash basin mixer Смеситель для умывальника Einloch Waschtischeinhebelmischer</p>	   <p>[583-715-00] uchwyt chrom [583-725-00] uchwyt chrom-satyna</p> <p>Bateria umywalkowa / zlewozmywakowa stojąca Wash basin mixer / sink mixer Смеситель для мойки и умывальника с боковой ручкой - рычагом Aufputz Wasch- und Spültischeinhebelmischer</p>	  <p>[582-712-00] uchwyt chrom [582-722-00] uchwyt chrom-satyna</p> <p>Bateria umywalkowa nablatowa Single hole wash basin mixer Смеситель для свободностоящих раковин Einloch Waschtischeinhebelmischer</p>

  <p>[587-015-00] uchwyt chrom [587-025-00] uchwyt chrom-satyna</p> <p>Bateria bidetowa stojąca Bidet mixer Смеситель для биде Einloch Bideteinhebelmischer</p>	   <p>[583-815-00] uchwyt chrom [583-825-00] uchwyt chrom-satyna</p> <p>Bateria umywalkowo / zlewozmywakowa stojąca Wash basin mixer / sink mixer Смеситель для мойки и умывальника с боковой ручкой - рычагом Aufputz Wasch- und Spültischeinhebelmischer</p>	  <p>[583-615-00] uchwyt chrom [583-625-00] uchwyt chrom-satyna</p> <p>Bateria zlewozmywakowa stojąca Single hole sink mixer Смеситель для мойки Einloch Spültischeinhebelmischer</p>	  <p>[583-310-00] uchwyt chrom [583-320-00] uchwyt chrom-satyna</p> <p>Bateria zlewozmywakowa stojąca z wyciąganą wylewką Single hole sink mixer with handshower Смеситель для мойки с выдвижным изливом Einloch Spültischeinhebelmischer mit Handbrause</p>
  <p>[583-210-00] uchwyt chrom [583-220-00] uchwyt chrom-satyna</p> <p>Bateria zlewozmywakowa stojąca z wyciąganym natryskiem Single hole sink mixer with handshower Смеситель для мойки с выдвижным душем Einloch Spültischeinhebelmischer mit Handbrause</p>	  <p>[583-110-00] uchwyt chrom [583-120-00] uchwyt chrom-satyna</p> <p>Bateria zlewozmywakowa stojąca z wyciąganym natryskiem L=215 mm Single hole sink mixer with handshower Смеситель для мойки с выдвижным душем Einloch Spültischeinhebelmischer mit Handbrause</p>	  <p>[583-915-00] uchwyt chrom [583-925-00] uchwyt chrom-satyna</p> <p>Bateria zlewozmywakowa stojąca z obrotowym wylotem L=212 mm Single hole sink mixer Смеситель для мойки с поворотным изливом Einloch Spültischeinhebelmischer</p>	

baterie jednouchwytowe CYRKON DECORUM



























single lever mixers CYRKON DECORUM



Koniec z nudą. CYRKON DECORUM to rzemiosło w pięknej oprawie. Unikalne i oryginalne motywy zdobnicze są znakiem rozpoznawczym oraz siłą całej kolekcji. Krótkoseryjny charakter nadaje tej rodzinie prestiżu i nobilituje jej użytkowników.

Dla wszystkich, którzy cenią oryginalność i wzornictwo na najwyższym poziomie.

End to boredom. CYRKON DECORUM is a craft in a beautiful frame. Unique and original decorative motives are the countersign and the strength of the whole collection. A small scale character giving this collection a prestige and ennobles its users. For all those who appreciate originality and high class design.

  <p>[584-030-00]</p> <p>Bateria wannowa ścienna Bath mixer Смеситель для ванны Brauseeinhebelmischer ohne Duschset</p>	  <p>[585-230-00]</p> <p>Bateria wannowa trójotworowa stojąca Three-hole bath mixer Стойчий смеситель для ванны в трех отверстиях Dreiloch Wannenfülleinhebelmischer</p>	  <p>[586-030-00]</p> <p>Bateria natryskowa ścienna Shower mixer Смеситель для душа Aufputz Brauseeinhebelmischer ohne Duschset</p>	  <p>[589-430-00]</p> <p>Bateria wannowa podtynkowa z przyłączem do zestawu natryskowego (element sterujący) Built-in bath mixer Смеситель для ванны скрытого монтажа Unterputz Wannenfülleinhebelmischer</p>
  <p>[836-001-00]</p> <p>Wylot do baterii wannowej podtynkowej Outlet Вылет воды для смесителя скрытого монтажа Ausguss</p>	  <p>[589-630-00]</p> <p>Bateria natryskowa podtynkowa (element sterujący) Built-in shower mixer Смеситель для душа скрытого монтажа Unterputz Brauseeinhebelmischer</p>	  <p>[845-100-00]</p> <p>Dysk natryskowy z ramieniem L=380 mm Shower disk L=380 mm Душевой диск L=380 mm Duschteller L=380 mm</p>	  <p>[845-101-00]</p> <p>Głowica natryskowa z ramieniem L=280 mm Shower head L=280 mm Душевая головка L=280 mm Duschkopf L=280 mm</p>
   <p>[580-830-00] [580-930-00]</p> <p>Bateria umywalkowa / zlewozmywakowa ścienna L=150 mm / 200 mm Wash basin mixer / sink mixer Смеситель для мойки и умывальника Aufputz Wasch- und Spültischeinhebelmischer</p>	  <p>[582-835-00]</p> <p>Bateria umywalkowa stojąca Single hole wash basin mixer Смеситель для умывальника Einloch Waschtischeinhebelmischer</p>	   <p>[583-735-00]</p> <p>Bateria umywalkowa / zlewozmywakowa stojąca Wash basin mixer / sink mixer Смеситель для мойки и умывальника с боковой ручкой - рычагом Aufputz Wasch- und Spültischeinhebelmischer</p>	  <p>[582-732-00]</p> <p>Bateria umywalkowa stojąca nablatowa Single hole wash basin mixer Смеситель для свободностоящих раковин Einloch Waschtischeinhebelmischer</p>



[587-035-00]

Bateria bidetowa stojąca
Bidet mixer
Смеситель для биде
Einloch Bideteinhebelmischer



[583-835-00]

Bateria zlewozmywakowa stojąca
Single hole sink mixer
Смеситель для мойки с боковой ручкой - рычагом
Einloch Spültischeinhebelmischer



[583-635-00]

Bateria umywalkowo / zlewozmywakowa stojąca
Wash basin mixer / sink mixer
Смеситель для мойки и умывальника с боковой ручкой - рычагом
Aufputz Wasch- und Spültischeinhebelmischer



[583-330-00]

Bateria zlewozmywakowa stojąca
Single hole sink mixer with handshower
Смеситель для мойки с выдвижным изливом
Einloch Spültischeinhebelmischer mit Handbrause



[583-230-00]

Bateria zlewozmywakowa stojąca z wyciąganym natryskiem
Single hole sink mixer with handshower
Смеситель для мойки с выдвижным душем
Einloch Spültischeinhebelmischer mit Handbrause



[583-130-00]

Bateria zlewozmywakowa stojąca z wyciąganym natryskiem L=215 mm
Single hole sink mixer with handshower
Смеситель для мойки с выдвижным душем
Einloch Spültischeinhebelmischer mit Handbrause



[583-935-00]

Bateria zlewozmywakowa stojąca z obrotowym wylotem L=212 mm
Single hole sink mixer
Смеситель для мойки с поворотным изливом
Einloch Spültischeinhebelmischer



Nowość

baterie jednouchwytowe DIAMENT

single lever mixers DIAMENT



Baterie DIAMENT o łagodnych kształtach są gwarancją oryginalności i najwyższej jakości produktu. Ciekawa, niebanalna forma zbudowana w oparciu o miękkie krawędzie, nadaje serii wyjątkowego charakteru. Baterie polerowane ręcznie, w tradycyjnej technologii to niepowtarzalny efekt ludzkiej pracy i odzwierciedlenie żywej pasji tworzenia.

DIAMENT mixers with mild shapes, guarantee originality and top quality product. Interesting, original form based on soft, edges gives the collection a unique character. Mixers polished manually in traditional technology are a unique effect of human effort and a reflection of a real passion of creation.



[4104-010-00]

Bateria wannowa ścienna
Bath mixer
Смеситель для ванны
Aufputz Wannenfüll- und
Brauseeinhebelmischer ohne Duschset



[4106-010-00]

Bateria natryskowa ścienna
Shower mixer
Смеситель для душа
Aufputz Brauseeinhebelmischer ohne
Duschset



[4102-811-00]

**Bateria umywalkowa stojąca
z zaworami kątowymi**
Single hole wash basin mixer
Смеситель для умывальника
Einloch Waschtischeinhebelmischer



[4107-011-00]

**Bateria bidetowa stojąca
z zaworami kątowymi**
Bidet mixer
Смеситель для биде
Einloch Bideteinhebelmischer



[4103-915-00]

Bateria zlewozmywakowa stojąca
Single hole sink mixer
Смеситель для мойки
Einloch Spültischeinhebelmischer





baterie jednouchwytowe JANTAR

single lever mixers JANTAR



Jedynie na świecie baterie z wkomponowanym w uchwyt naturalnym bursztynem pochodzącym z Morza Bałtyckiego. Unikalny styl i dodające smaku złocenia 24-karatowym złotem sprawiają, iż baterie te doskonale komponują się z wystrojem eleganckich łazienek. Baterie JANTAR z powodzeniem można uznać za udane połączenie sztuki jubilerskiej i użytkowej. Rodzina ta została nagrodzona Złotym Medalem na Międzynarodowych Targach Poznańskich.

Mixers unique in the World with natural amber in the handle originated from the Baltic Sea. Unique style and spicing up gilt with 24 carat gold make the mixers composed well with the interior of elegant bathrooms. The JANTAR mixers may be well recognised as a successful combination of jewel and applied art. The collection was awarded with a gold medal at the Poznań Internation Fair.





[474-030-03]

Bateria wannowa ścienna
Bath mixer
Смеситель для ванны
Aufputz Wannenfüll- und
Brauseeinhebelmischer ohne Duschset



[475-230-03]

Bateria wannowa trójotworowa stojąca
Three-hole bath mixer
Стойчий смеситель для ванны в трех
отверстиях
Dreiloch Wannenfülleinhebelmischer



[476-030-03]

Bateria natryskowa ścienna
Shower mixer
Смеситель для душа
Aufputz Brauseeinhebelmischer ohne
Duschset



[472-835-03]

Bateria umywalkowa stojąca
Single hole wash basin mixer
Смеситель для умывальника
Einloch Waschtischeinhebelmischer



[477-035-03]

Bateria bidetowa stojąca
Bidet mixer
Смеситель для биде
Einloch Bideteinhebelmischer



[473-130-03]

**Bateria zlewozmywakowa stojąca
z wyciąganym natryskiem L=205 mm**
Single hole sink mixer with handshower
Смеситель для мойки с выдвижным
душем
Einloch Spültischeinhebelmischer mit
Handbrause



[473-935-03]

**Bateria zlewozmywakowa stojąca
z obrotową wylewką L=210 mm**
Single hole sink mixer
Смеситель для мойки с поворотным
изливом
Einloch Spültischeinhebelmischer



Nowość

baterie jednouchwytowe KORUND

single lever mixers KORUND



KORUND to odzwierciedlenie najnowszych trendów we współczesnej sztuce użytkowej. Niestandardowe rozwiązanie w postaci asymetrycznej wylewki w baterii wannowej oraz połączenie prostych linii z delikatnymi łukami pozwoliło uzyskać niezmiernie interesujący efekt. Współczesna łazienka inspirowana minimalizmem w projektowaniu wnętrz będzie doskonałą sceną dla baterii KORUND.

KORUND is a reflection of the latest trends in modern applied art. Non-standard solution in the form of an asymmetric spout in the bathtub and a combination of straight lines with delicate arches permitted achieving a very interesting effect. A modern bathroom inspired with minimalism in interior designing should be excellent scenery for KORUND mixers.



[4004-010-00]

Bateria wannowa ścienna
Bath mixer
Смеситель для ванны
Aufputz Wannenfüll- und
Brauseeinhebelmischer ohne Duschset



[4006-010-00]

Bateria natryskowa ścienna
Shower mixer
Смеситель для душа
Aufputz Brauseeinhebelmischer ohne
Duschset



[4002-811-00]

**Bateria umywalkowa stojąca
z zaworami kątowymi**
Single hole wash basin mixer
Смеситель для умывальника
Einloch Waschtischeinhebelmischer



[4007-011-00]

**Bateria bidetowa stojąca
z zaworami kątowymi**
Bidet mixer
Смеситель для биде
Einloch Bideteinhebelmischer



[4003-915-00]

Bateria zlewozmywakowa stojąca
Single hole sink mixer
Смеситель для мойки
Einloch Spültischeinhebelmischer



























baterie jednouchwytowe KWARC

single lever mixers KWARC



Baterie KWARC to subtelna delikatność i klasyka formy. Charakterystycznym detalem jest uchwyt wyróżniający się nieszablonowym kształtem. Odpowiednio wyprofilowany wzmacnia walory wizualne baterii oraz podnosi jej funkcjonalność.

The KWARC mixers are the subtle softness and classic of form. Its characteristic detail is the handle with an unconventional shape, which profiled suitably intensifies the visual values of the mixer and increases its functionality.

  <p>[4204-010-00]</p> <p>Bateria wannowa ścienna Bath mixer Смеситель для ванны Aufputz Wannenfäll- und Brauseeinhebelmischer ohne Duschset</p>	  <p>[4205-210-00]</p> <p>Bateria wannowa trójotworowa stojąca Three-hole bath mixer Стоячий смеситель для ванны в трех отверстиях Dreiloch Wannenfäll-einhebelmischer</p>	  <p>[4206-010-00]</p> <p>Bateria natryskowa ścienna Shower mixer Смеситель для душа Aufputz Brauseeinhebelmischer ohne Duschset</p>	  <p>[4209-410-00]</p> <p>Bateria wannowa podtynkowa z przyłączem do zestawu natryskowego (element sterujący) Built-in bath mixer Смеситель для ванны скрытого монтажа Unterputz Wannenfäll-einhebelmischer</p>
  <p>[836-001-00]</p> <p>Wylot do baterii wannowej podtynkowej Outlet Вылет воды для смесителя скрытого монтажа Ausguss</p>	  <p>[4209-610-00]</p> <p>Bateria natryskowa podtynkowa (element sterujący) Built-in shower mixer Смеситель для душа скрытого монтажа Unterputz Brauseeinhebelmischer</p>	  <p>[845-100-00]</p> <p>Dysk natryskowy z ramieniem L=380 mm Shower disk L=380 mm Душевой диск L=380 mm Duschteller L=380 mm</p>	  <p>[845-101-00]</p> <p>Głowica natryskowa z ramieniem L=280 mm Shower head L=280 mm Душевая головка L=280 mm Duschkopf L=280 mm</p>
  <p>[4202-815-00]</p> <p>Bateria umywalkowa stojąca Single hole wash basin mixer Смеситель для умывальника Einloch Waschtischeinhebelmischer</p>	  <p>[4207-015-00]</p> <p>Bateria bidetowa stojąca Bidet mixer Смеситель для биде Einloch Bideteinhebelmischer</p>	  <p>[4203-915-00]</p> <p>Bateria zlewozmywakowa stojąca z obrotowym wylotem Single hole sink mixer Смеситель для мойки с поворотным изливом Einloch Spültischeinhebelmischer</p>	



Nowość

baterie jednouchwytowe

MALACHIT

single lever mixers MALACHIT



Rodzina baterii MALACHIT wyróżnia się oryginalnym wzornictwem i funkcjonalnością. Na jej wyjątkowość składa się specjalnie zaprojektowany uchwyt o charakterystycznym kształcie. W ofercie znajdziemy baterie stojące, ściennie – do łazienki i do kuchni. Wybór odpowiedniej baterii sprawia, że łazienka staje się miejscem wyjątkowym, sprzyjającym relaksowi i wypoczynkowi.

The MALACHIT mixer family characterises original design and functionality. Its exceptionality comes from specially designed characteristic shaped handle. The offer consists of standing and wall mixers for bathrooms and kitchens. Choosing a suitable mixer makes ones bathroom an exceptional place, conducive for relaxation.



[4404-510-00]

Bateria wannowa ścienna z natryskiem ręcznym
Bath mixer with manual shower set
Смеситель для ванны с ручным душем
Aufputz Wannenfüll – und Brausearmatur mit Handbrause



[4406-510-00]

Bateria natryskowa ścienna z natryskiem ręcznym
Shower mixer with manual shower set
Смеситель для душа с ручным душем
Aufputz Brausearmatur mit Handbrause



[4402-811-00]

Bateria umywalkowa stojąca z zaworami kątowymi
Single hole wash basin mixer
Смеситель для умывальника с угловым кранами выпуском полу-автоматом
Einloch Waschtischarmatur



[4407-011-00]

Bateria bidetowa stojąca z zaworami kątowymi
Bidet mixer
Смеситель для биде с угловыми кранами и выпуском полу-автоматом
Einloch Bidetarmatur



[4403-915-00]

Bateria zlewozmywakowa stojąca
Single hole sink mixer
Смеситель для мойки
Einloch Spültischarmatur

PROMOCJA!

W KOMPLECIE
ZAWORY KĄTOWE
ORAZ SPUST TYPU
KLIK-KLAK



1x

2x



























baterie jednouchwytowe RUBIN

single lever mixers RUBIN



Dynamiczny kształt baterii z rodziny RUBIN emanuje energią. Subtelne połączenie chromu i satyny otwiera nowe możliwości aranżacji wnętrza. Baterie RUBIN to idealna kompozycja klasyki, funkcjonalności i jednocześnie lekkiej ekstrawagancji. Czysty dynamizm i ekspresja to gwarancja imponującego efektu w Twojej łazience i kuchni.

The dynamic shape of the RUBIN collection mixers emanates with energy. A subtle combination of chrome and satin brings new ways of interior arrangements. RUBIN mixers make an ideal composition of classics, functionality and a subtle extravagance at the same time. Clean dynamism and expression guarantee impressive effect in ones bathroom and kitchen.

  <p>[564-010-00]</p> <p>Bateria wannowa ścienna Bath mixer Смеситель для ванны Aufputz Wannenfäll- und Brauseeinhebelmischer ohne Duschset</p>	  <p>[565-210-00]</p> <p>Bateria wannowa trójotworowa stojąca Three-hole bath mixer Стойчий смеситель для ванны в трех отверстиях Dreiloch Wannenfäll-einhebelmischer</p>	  <p>[566-010-00]</p> <p>Bateria natryskowa ścienna Shower mixer Смеситель для душа Aufputz Brauseeinhebelmischer ohne Duschset</p>	  <p>[569-410-00]</p> <p>Bateria wannowa podtynkowa z przyłączem do zestawu natryskowego (element sterujący) Built-in bath mixer Смеситель для ванны скрытого монтажа Unterputz Wannenfäll-einhebelmischer</p>
  <p>[836-001-00]</p> <p>Wylot do baterii wannowej podtynkowej Outlet Вылет воды для смесителя скрытого монтажа Ausguss</p>	  <p>[569-610-00]</p> <p>Bateria natryskowa podtynkowa (element sterujący) Built-in shower mixer Смеситель для душа скрытого монтажа Unterputz Brauseeinhebelmischer</p>	  <p>[845-100-00]</p> <p>Dysk natryskowy z ramieniem L=380 mm Shower disk L=380 mm Душевой диск L=380 mm Duschteller L=380 mm</p>	  <p>[845-101-00]</p> <p>Głowica natryskowa z ramieniem L=280 mm Shower head L=280 mm Душевая головка L=280 mm Duschkopf L=280 mm</p>
  <p>[562-815-00]</p> <p>Bateria umywalkowa stojąca Single hole wash basin mixer Смеситель для умывальника Einloch Waschtischeinhebelmischer</p>	  <p>[567-015-00]</p> <p>Bateria bidetowa stojąca Bidet mixer Смеситель для биде Einloch Bideteinhebelmischer</p>	  <p>[563-110-00]</p> <p>Bateria zlewozmywakowa stojąca z wyciąganym natryskiem L=205 mm Single hole sink mixer with handshower Смеситель для мойки с выдвижным душем Einloch Spültischeinhebelmischer mit Handbrause</p>	  <p>[563-915-00]</p> <p>Bateria zlewozmywakowa stojąca L=230 mm Single hole sink mixer Смеситель для мойки Einloch Spültischeinhebelmischer</p>



baterie termostaticzne

EXCLUSIVE

mixers with thermostat EXCLUSIVE



Baterie EXCLUSIVE stanowią przykład nowoczesnego i eleganckiego wzornictwa. Masywna forma złagodzona eliptycznymi łukami sprawia, iż baterie te pasują idealnie do dużych wanien oraz kabin natryskowych. System termostaticzny gwarantuje bezpieczeństwo oraz komfort kąpiel. Całość stanowi doskonałą propozycję dla wymagających Klientów.

The EXCLUSIVE mixers make an example of modern and elegant design. Massive form softened with elliptic arches makes the mixers ideally suited for large bathtubs and shower enclosures. A thermostatic system provides safety and bath comfort. All makes an excellent offer for demanding clients.



[574-011-00]

Bateria termostatyczna wannowa

Bath mixer with thermostat

Термостатический смеситель для ванны

Aufputz Wannenfüll- und Brausethermostat ohne Duschset



[576-011-00]

Bateria termostatyczna natryskowa

Shower mixer with thermostat

Термостатический смеситель для душа

Aufputz Brausethermostat ohne Duschset



baterie zlewozmywakowe KUCHENNE

sink mixers KITCHEN



Chwile spędzone w kuchni mogą teraz być naprawdę przyjemne. Pasja przyrządzania posiłków w dobrze zorganizowanym otoczeniu, którego kluczowym elementem jest praktyczna i działająca bez zarzutu bateria kuchenna. Ergonomia, funkcjonalność oraz niebanalny design to kwintesencja baterii zlewozmywakowych Armatury Kraków. W ofercie dostępne są baterie kuchenne w ramach wybranej kolekcji jak również modele indywidualne.

Moments spent in the kitchen may be now really pleasant. The passion of preparing meals in a well organized environment, where the key element is a practical and efficient kitchen mixer. Ergonomics, functionality and original design is the essence of the sink mixers Manufactured by Armatura Kraków. Our offer consists of kitchen mixers within a chosen collection as well as individual models.

Nowość



[6503-915-00]

Bateria zlewozmywakowa GAMMA
Single hole sink mixer
Смеситель для мойки
Einloch Spültischarmatur



[6703-915-00]

Bateria zlewozmywakowa DELTA
Single hole sink mixer
Смеситель для мойки
Einloch Spültischeinhebelmischer



[6603-915-00]

Bateria zlewozmywakowa OMEGA
Single hole sink mixer
Смеситель для мойки
Einloch Spültischeinhebelmischer



[6603-110-00]

Bateria zlewozmywakowa SIGMA
stojąca z wyciąganą wylewką
Single hole sink mixer with handshower
Смеситель для мойки с выдвижным изливом
Einloch Spültischeinhebelmischer
mit Handbrause





Royal Class

Tęsknota za przeszłością – wszystko ponownie w zasięgu ręki. Kolekcja Royal to klasyka w najlepszym wydaniu. Perfekcyjnie skomponowana propozycja dla wszystkich, którzy cenią tradycyjne wnętrza i pragną czerpać niczym nieograniczoną przyjemność z rytuału kąpieli. W dobie narastającego pośpiechu warto zatrzymać się – spojrzeć za siebie i delektować się przyjemnymi chwilami z dawnych lat.

Nostalgia for old times – all within hands reach again. Royal collection – this is the classic in its best edition. Perfectly composed offer for all those who appreciate traditional interiors and desire to derive unlimited pleasure from the ritual of a bath. In the era of increasing haste it is worth to wind down, look back and relish pleasant past moments.

Royal Class

retro classic
retro



Royal Class | Retro Classic

[385-120-00] chrom
[385-120-05] patyna

Bateria wannowa stojąca
z podłączeniem do posadzki
Free standing bath mixer
Смеситель для ванны для монтажа в пол
Aufputz Zweigriff Wannenfüll- und
Brausearmatur mit Duschset



baterie dwuuchwytowe

RETRO CLASSIC

double lever mixers RETRO CLASSIC

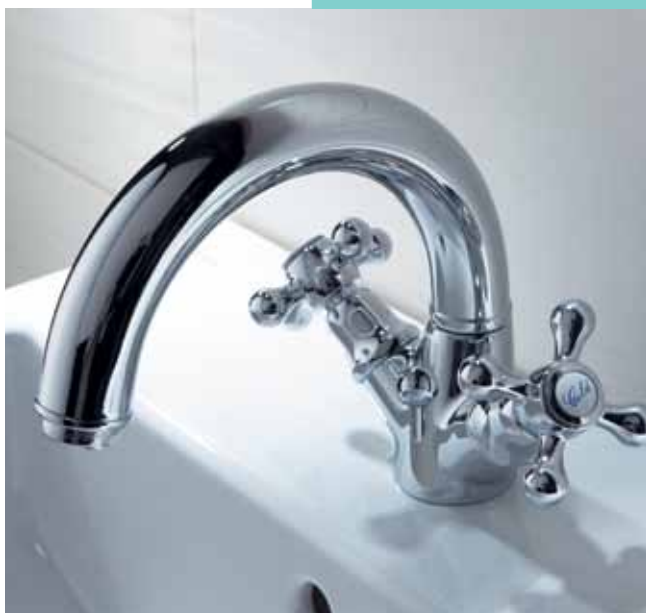

Rodzina RETRO CLASSIC nawiązuje swoim stylem do najlepszych tradycji wnętrzarskich i artystycznych. Detale wykonane z prawdziwej porcelany podkreślają wyszukaną i oryginalną stylistykę. W bezpośredni sposób nawiązują do baterii produkowanych przez Armaturę Kraków w latach trzydziestych ubiegłego stulecia. Na szczególną uwagę zasługują baterie wannowe montowane bezpośrednio na posadzce.

The RETRO CLASSIC collection refers with its style to the best artistic and interior decoration traditions. Details made of real porcelain emphasize sophisticated and original stylistics. Directly refer to mixers manufactured by Armatura Kraków on the 30th of the last century. Special attention should be paid to bathtub mixers installed directly on the floor.

  <p>[384-120-00] chrom [384-120-03] chrom-złoto [384-120-05] patyna</p> <p>Bateria wannowa ścienna Bath mixer Смеситель для ванны Aufputz Zweigriff Wannenfüll- und Brausearmatur mit Duschset</p>	  <p>[385-120-00] chrom [385-120-05] patyna</p> <p>Bateria wannowa stojąca z podłączeniem do posadzki Free standing bath mixer Смеситель для ванны для монтажа в пол Aufputz Zweigriff Wannenfüll- und Brausearmatur mit Duschset</p>	  <p>[386-321-00] chrom [386-321-03] chrom-złoto [386-321-05] patyna</p> <p>Bateria natryskowa ścienna z natryskiem przesuwnym Shower mixer with shower set Смеситель для душа с передвижным душем Aufputz Zweigriff Brausearmatur mit Duschset</p>	  <p>[380-320-00] chrom [380-320-03] chrom-złoto [380-320-05] patyna</p> <p>Bateria umywalkowa ścienna L=160 mm Wall-mounted wash basin mixer Смеситель для умывальника Aufputz Zweigriff Waschtischarmatur</p>
  <p>[380-520-00] chrom [380-520-03] chrom-złoto [380-520-05] patyna</p> <p>Bateria umywalkowa ścienna L=250 mm Wall-mounted wash basin mixer Смеситель для умывальника Aufputz Zweigriff Waschtischarmatur</p>	  <p>[380-420-00] chrom [380-420-03] chrom-złoto [380-420-05] patyna</p> <p>Bateria zlewozmywakowa ścienna L=160 mm Wall-mounted sink mixer Смеситель для мойки Aufputz Zweigriff Spültischarmatur</p>	  <p>[380-620-00] chrom [380-620-03] chrom-złoto [380-620-05] patyna</p> <p>Bateria zlewozmywakowa ścienna L=250 mm Wall-mounted sink mixer Смеситель для мойки Aufputz Zweigriff Spültischarmatur</p>	  <p>[382-825-00] chrom [382-825-03] chrom-złoto [382-825-05] patyna</p> <p>Bateria umywalkowa stojąca Single hole wash basin mixer Смеситель для умывальника Einloch Zweigriff Waschtischarmatur</p>
  <p>[382-325-00] chrom [382-325-03] chrom-złoto [382-425-00] chrom [382-425-03] chrom-złoto</p> <p>Bateria umywalkowa stojąca wysokość wylewki L=80 mm / 165 mm Single hole wash basin mixer Смеситель для умывальника Einloch Zweigriff Waschtischarmatur</p>	  <p>[387-325-00] chrom [387-325-03] chrom-złoto [387-325-05] patyna</p> <p>Bateria bidetowa stojąca Bidet mixer Смеситель для биде Einloch Zweigriff Bidetarmatur</p>	  <p>[383-120-00] chrom [383-120-03] chrom-złoto</p> <p>Bateria zlewozmywakowa stojąca z wyciąganym natryskiem Single hole sink mixer with handshower Смеситель для мойки с выдвижным душем Einloch Zweigriff Spültischarmatur mit Handbrause</p>	  <p>[383-925-00] chrom [383-925-03] chrom-złoto [383-925-05] patyna</p> <p>Bateria zlewozmywakowa stojąca Single hole sink mixer Смеситель для мойки Einloch Zweigriff Spültischarmatur</p>



baterie dwuuchwytowe RETRO

double lever mixers RETRO



Odrobina historii, szczypta niepowtarzalnego klimatu i tradycyjny kształt – to baterie RETRO. Niewielki przedmiot, element wykończenia wnętrza nadający mu osobisty charakter. To wyjątkowy atrybut pozwalający stworzyć ponadczasowy nastrój w łazience i kuchni. Baterie RETRO koncentrują się na komforcie, pięknie i funkcjonalności.

A bit of history, an inch of unique climate and traditional shape – these are the RETRO mixers. Small item, finish element of interior, giving it a personal character. It is a unique attribute allowing creating a timeless atmosphere in ones bathroom and kitchen. RETRO mixers concentrate on comfort, beauty and functionality.



  <p>[374-144-00] chrom [374-144-03] chrom-złoto</p> <p>Bateria wannowa ścienna Bath mixer Смеситель для ванны Aufputz Zweigriff Wannenfüll- und Brausearmatur mit Duschset</p>	  <p>[374-145-00] chrom [374-145-03] chrom-złoto</p> <p>Bateria wannowa ścienna, wylot z perlatozem Bath mixer Смеситель для ванны Aufputz Zweigriff Wannenfüll- und Brausearmatur mit Duschset</p>	   <p>[374-148-00] chrom [374-148-03] chrom-złoto</p> <p>Bateria wannowo / umywalkowa ścienna Bath mixer with long spout Смеситель для ванны и умывальника Aufputz Zweigriff Wannenfüll- und Brausearmatur mit Duschset</p>	  <p>[375-140-00] chrom</p> <p>Bateria wannowa stojąca z podłączeniem do posadzki Free standing bath mixer Смеситель для ванны для монтажа в пол Aufputz Zweigriff Wannenfüll- und Brausearmatur mit Duschset</p>
  <p>[376-540-00] chrom [376-540-03] chrom-złoto</p> <p>Bateria natryskowa ścienna z natryskiem punktowym Shower mixer with shower set Смеситель для душа с точечным душем Aufputz Zweigriff Brausearmatur mit Duschset</p>	  <p>[376-340-00] chrom [376-340-03] chrom-złoto</p> <p>Bateria natryskowa ścienna z natryskiem przesuwnym Shower mixer with shower set Смеситель для душа с передвижным душем Aufputz Zweigriff Brausearmatur mit Duschset</p>	  <p>[370-340-00] / [370-540-00] chrom [370-340-03] / [370-540-03] chrom-złoto</p> <p>Bateria umywalkowa ścienna L=160 mm / L=250 mm Wall-mounted wash basin mixer Смеситель для умывальника Aufputz Zweigriff Waschtischarmatur</p>	  <p>[370-440-00] / [370-640-00] chrom [370-440-03] / [370-640-03] chrom-złoto</p> <p>Bateria zlewozmywakowa ścienna L=160 mm / L=250 mm Wall-mounted sink mixer Смеситель для мойки Aufputz Zweigriff Spültischarmatur</p>
   <p>[372-345-00] / [373-445-00] chrom [372-345-03] / [373-445-03] chrom-złoto</p> <p>Bateria umywalkowo / zlewozmywakowa stojąca Wash basin mixer / sink mixer Смеситель для мойки и умывальника Einloch Zweigriff Wasch-Spültischarmatur</p>	  <p>[372-845-00] chrom [372-845-03] chrom-złoto</p> <p>Bateria umywalkowa stojąca Single hole wash basin mixer Смеситель для умывальника Einloch Zweigriff Waschtischarmatur</p>	  <p>[377-045-00] chrom [377-045-03] chrom-złoto</p> <p>Bateria bidetowa stojąca Bidet mixer Смеситель для биде Einloch Bideteinhebelmischer</p>	



Middle Class

Kolekcja Middle Class to gwarancja jakości. Niezawodna i oryginalna forma zbudowana jest w oparciu o wieloletnie doświadczenie. Odważne, nowoczesne i zarazem funkcjonalne propozycje są odpowiedzią na potrzeby Klienta zwracającego uwagę na ergonomię, niebanalną estetykę i przystępną cenę.

The Middle Class collection is a guaranteed quality. Reliable and original form based on many years of experience. Brave, modern and at the same time functional offer are the best answer to requirements of a customer who considers ergonomics, original aesthetics and a reasonable price.

Middle Class | Symetric

[344-010-00] chrom
[344-010-04] satyna-chrom

Bateria wannowa ścienna
Bath mixer
Смеситель для ванны
Zweigriff Wannenfüll- und
Brausearmatur ohne Duschset



Middle Class

albit – new
bazalt – new
obsydian – new
salit – new
nefryt
piryt
rodon
harmonic
symetric
baterie termostaticzne – STANDARD
baterie termostaticzne – CLASSIC



Nowość

baterie jednouchwytowe











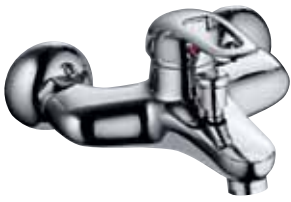



ALBIT

single lever mixers ALBIT



Rodzina ALBIT charakteryzuje się klasycznym wzornictwem. Uchwyt i korpus tworzą doskonale dopasowany zestaw. W kolekcji dostępne są baterie przeznaczone do łazienki i do kuchni. Oprócz standardowych rozwiązań kolekcja została uzupełniona o baterię wannową dwuotworową. Albit idealnie sprawdza się w małych wnętrzach, subtelnie wydobywając ich charakter.

The ALBIT family characterises with classic design. The corp and the handle make an excellently suited set. The collection consists of mixers for bathrooms and kitchens. Apart from the standard solutions, the collection offers a double hole bathtub mixer. Albit ideally suits small spaces and subtly emphasise its character.

  <p>[4604-010-00]</p> <p>Bateria wannowa ścienna Bath mixer Смеситель для ванны Aufputz Wannenfüll- und Brauseeinhebelmischer ohne Duschset</p>	  <p>[4605-011-00]</p> <p>Bateria wannowa stojąca Bath mixer Смеситель для ванны Zweiloch Wannenfüll- und Brausearmatur ohne Duschset</p>	  <p>[4606-010-00]</p> <p>Bateria natryskowa ścienna Shower mixer Смеситель для душа Aufputz Brausearmatur ohne Duschset</p>	  <p>[4602-815-00]</p> <p>Bateria umywalkowa stojąca Single hole wash basin mixer Смеситель для умывальника Einloch Waschtischarmatur</p>
  <p>[4602-915-00]</p> <p>Bateria umywalkowa stojąca z obrotową wylewką L=145 mm Single hole wash basin with rotary spout Смеситель для умывальника с поворотным изливом Einloch Waschtischarmatur</p>	  <p>[4607-015-00]</p> <p>Bateria bidetowa stojąca Bidet mixer Смеситель для биде Einloch Bidetarmatur</p>	 <p>[4603-815-00]</p> <p>Bateria zlewozmywakowa stojąca z obrotową wylewką L=210 mm Single hole sink mixer Смеситель для мойки Einloch Spültischarmatur</p>	 <p>[4603-110-00]</p> <p>Bateria zlewozmywakowa stojąca z wyciąganym natryskiem L=205 mm Single hole sink mixer with handshower Смеситель с выдвижным душем Einloch Spültischeinhebelmischer mit Handbrause</p>



Nowość

baterie jednouchwytowe

















BAZALT

single lever mixers BAZALT



Jeżeli pragniesz znaleźć idealne rozwiązanie dopełnienia aranżacji swojej łazienki, jeżeli pragniesz mu dodać odrobinę elegancji i wyrafinowania to baterie BAZALT są do tego idealnie stworzone. Cylindryczny, lekko pochylony korpus nadaje im dynamicznego wyrazu złagodzonego delikatnym kształtem uchwytu. Inspiracją do jego zaprojektowania było wykorzystanie bryły walca wraz z przenikającymi się liniami eliptycznymi.

If you wish to find an ideal solution for completing the arrangement of your bathroom and you desire to add a pinch of elegance and sophistication – the BAZALT mixers are ideal for that. Cylindrical, slightly sloped corp gives it dynamic character, softened by the delicate shape of the handle. The inspiration for its design was an idea of the body of a cylinder with elliptic lines penetrating through.

  <p>[4704-010-00]</p> <p>Bateria wannowa ścienna Bath mixer Смеситель для ванны Aufputz Wannenfäll- und Brausearmatur ohne Duschset</p>	  <p>[4706-010-00]</p> <p>Bateria natryskowa ścienna Shower mixer Смеситель для душа Aufputz Brausearmatur ohne Duschset</p>	  <p>[4700-810-00]</p> <p>Bateria umywalkowa ścienna L=150 mm Wash basin mixer with rotary spout Смеситель для умывальника с поворотным изливом Aufputz Waschtischarmatur</p>	  <p>[4700-910-00]</p> <p>Bateria zlewozmywakowa ścienna L=200 mm Single hole sink mixer with rotary spout Смеситель для мойки с поворотным изливом Aufputz Spültischarmatur</p>
  <p>[4702-815-00]</p> <p>Bateria umywalkowa stojąca Single hole wash basin mixer Смеситель для умывальника Einloch Waschtischarmatur</p>	  <p>[4702-915-00]</p> <p>Bateria umywalkowa stojąca z obrotową wylewką L=145 mm Single hole wash basin mixer with rotary spout Смеситель для умывальника с поворотным изливом Einloch Waschtischarmatur</p>	  <p>[4707-015-00]</p> <p>Bateria bidetowa stojąca Bidet mixer Смеситель для биде Einloch Bidetarmatur</p>	  <p>[4703-815-00]</p> <p>Bateria zlewozmywakowa stojąca Single hole sink mixer Смеситель для мойки Einloch Spültischarmatur</p>



Nowość

baterie jednouchwytowe

OBSYDIAN

single lever mixers OBSYDIAN



OBSYDIAN – rodzina baterii posiadająca znak rozpoznawczy w postaci niepowtarzalnego uchwytu. Korpus baterii posiada bardzo prostą formę, która prowokująco kontrastuje z uchwytem o asymetrycznej bryle idealnie dopasowanym do kształtu dłoni. Baterie Obsyidian pasują do każdego rodzaju wnętrza, będąc odzwierciedleniem najnowszych trendów obowiązujących we wzornictwie.

OBSYDIAN – the mixer family with a unique handle as a sign of recognition. The corp of the mixer with a very simple line contrasting provocative with the asymmetric handle ideally fitting the shape of the palm. The Obsyidian mixers fit any kind of interior, being the image of the latest trend in designing.



[5104-010-00]

Bateria wannowa ścienna
Bath mixer
Смеситель для ванны
Aufputz Wannenfüll- und Brausearmatur ohne Duschset



[5106-010-00]

Bateria natryskowa ścienna
Shower mixer
Смеситель для душа
Aufputz Brausearmatur ohne Duschset



[5100-810-00]

Bateria umywalkowa ścienna L=150 mm
Single hole wash basin mixer
Смеситель для умывальника
Einloch Waschtischarmatur



[5100-910-00]

Bateria zlewozmywakowa ścienna
Single hole sink mixer
Смеситель для мойки
Aufputz Spültischarmatur



[5102-815-00]

Bateria umywalkowa stojąca
Single hole wash basin mixer
Смеситель для умывальника
Einloch Waschtischarmatur



[5102-915-00]

Bateria umywalkowa stojąca z obrotową wylewką L=150 mm
Single hole wash basin mixer with rotary spout
Смеситель для умывальника с поворотным изливом
Aufputz Waschtischarmatur



[5107-015-00]

Bateria bidetowa stojąca
Bidet mixer
Смеситель для биде
Einloch Bidetarmatur



[5103-915-00]

Bateria zlewozmywakowa stojąca L=300 mm
Single hole sink mixer
Смеситель для мойки
Einloch Spültischarmatur



Nowość

















baterie jednouchwytowe SALIT

single lever mixers SALIT



Żeby stworzyć przytulny zakątek w swoim domu nie trzeba sięgać daleko. Wystarczy nasza wyobraźnia połączona z osiągnięciami współczesnych projektantów. Rodzina baterii SALIT, symbioza klasyki i elegancji zawarta w jednej bryle. Idealnie połyskująca powierzchnia uchwytu w zaskakujący sposób poddaje się grze światła.

It isn't necessary to look far to create a cosy place in your own home. Our imagination combined with modern designers achievements will do. The SALIT mixer family, the symbiosis of classics and elegance closed in one body. Ideally glittering surface of the handle surprisingly plays with the light.

  <p>[4504-010-00]</p> <p>Bateria wannowa ścienna Bath mixer Смеситель для ванны Aufputz Wannenfäll- und Brausearmatur ohne Duschet</p>	  <p>[4505-011-00]</p> <p>Bateria wannowa stojąca dwuotworowa Two hole bath mixer Смеситель для ванны Zweiloch Wannenfäll- und Brausearmatur ohne Duschet</p>	  <p>[4506-010-00]</p> <p>Bateria natryskowa ścienna Shower mixer Смеситель для душа Aufputz Brausearmatur ohne Duschet</p>	  <p>[4502-815-00]</p> <p>Bateria umywalkowa stojąca Wash basin mixer Смеситель для умывальника Einloch Waschtischarmatur</p>
  <p>[4502-915-00]</p> <p>Bateria umywalkowa stojąca z obrotową wylewką L=145 mm Single hole wash basin mixer with rotary spout Смеситель для умывальника с поворотным изливом Einloch Waschtischarmatur</p>	  <p>[4507-015-00]</p> <p>Bateria bidetowa stojąca Bidet mixer Смеситель для биде Einloch Bidetarmatur</p>	  <p>[4503-815-00]</p> <p>Bateria zlewozmywakowa stojąca z obrotowym wylotem L=210 mm Single hole sink mixer Смеситель для мойки с поворотным изливом Einloch Spültischarmatur</p>	  <p>[4503-110-00]</p> <p>Bateria zlewozmywakowa stojąca z wyciąganym natryskiem L=205 mm Single hole sink mixer with handshower Смеситель для мойки с выдвижным душем Einloch Spültischarmatur</p>



baterie jednouchwytowe NEFRYT

single lever mixers NEFRYT



Wysoka jakość w przystępnej cenie. Idealna dla wszystkich, którzy cenią sobie nowoczesne i ekonomiczne rozwiązania. Bardzo popularna rodzina baterii jednouchwytowych produkowanych przez Armaturę Kraków. Rodzina baterii NEFRYT otrzymała Medal Europejski przyznawany przez Business Centre Club oraz Urząd Komitetu Integracji Europejskiej. Dostępne w powłoce chrom oraz chrom-satyna.

Top quality at a reasonable price. Ideal for all those who appreciate modern and economic solutions. A very popular single hole mixer family manufactured by Armatura Krakow. The NEFRYT mixers were awarded with the European Medal by the Business Centre Club and the Office of the Committee for European Integration. Available in chrome and chrome-satin finish version.



  <p>[504-010-00] chrom [504-010-04] satyna-chrom</p> <p>Bateria wannowa ścienna Bath mixer Смеситель для ванны Aufputz Wannenfüll- und Brauseeinhebelmischer ohne Duschset</p>	   <p>[508-710-00] chrom</p> <p>Bateria wannowo-umywalkowa ścienna L=350 mm Wall-mounted wash basin / bath mixer with long spout Смеситель для ванны и умывальника Aufputz Wannenfüll- und Brausearmatur ohne Duschse</p>	  <p>[505-011-00] chrom</p> <p>Bateria wannowa stojąca dwuotworowa Two-hole bath mixer Стойкий смеситель для ванны Zweiloch Wannenfüll- und Brausearmatur ohne Duschse</p>	  <p>[506-510-00] chrom [506-510-04] satyna-chrom [506-010-00] chrom bez natrysku [506-010-04] satyna-chrom bez natrysku</p> <p>Bateria natryskowa ścienna z natryskiem punktowym Shower mixer with shower set Смеситель для душа с точечным держателем для душевой лейки Aufputz Brausearmatur mit Duschset</p>
   <p>[500-810-00 / 500-910-00] chrom [500-810-04 / 500-910-04] satyna-chrom</p> <p>Bateria umywalkowa / zlewozmywakowa ścienna L=150 mm / 200 mm Wall-mounted wash basin / sink mixer Смеситель для мойки и умывальника Aufputz Wasch- und Spültischeinhebelmischer</p>	  <p>[502-815-00] chrom [502-815-04] satyna-chrom</p> <p>Bateria umywalkowa stojąca Single hole wash basin mixer Смеситель для умывальника Einloch Waschtischeinhebelmischer</p>	  <p>[502-915-00] chrom [502-915-04] satyna-chrom</p> <p>Bateria umywalkowa z obrotową wylewką L=150 mm Single hole wash basin mixer Смеситель для умывальника с поворотным изливом Einloch Waschtischarmatur</p>	  <p>[502-112-00] chrom</p> <p>Bateria umywalkowa stojąca z wyciąganym natryskiem Single hole wash basin mixer with handshower Смеситель для умывальника с выдвигаемым душем Einloch Waschtischeinhebelmischer</p>
  <p>[507-015-00] chrom [507-015-04] satyna-chrom</p> <p>Bateria bidetowa stojąca Bidet mixer Смеситель для биде Einloch Bidetarmatur</p>	  <p>[503-110-00] chrom [503-110-04] satyna-chrom</p> <p>Bateria zlewozmywakowa stojąca z wyciąganym natryskiem Single hole sink mixer with handshower Смеситель для мойки с выдвигаемым душем Einloch Spültischeinhebelmischer mit Handbrause</p>	  <p>[503-915-00] chrom [503-915-04] satyna-chrom</p> <p>Bateria zlewozmywakowa stojąca z obrotowym wylotem L=210 mm Single hole sink mixer Смеситель для мойки с поворотным изливом Einloch Spültischeinhebelmischer</p>	   <p>[503-813-00] chrom</p> <p>Bateria zlewozmywakowa z dodatkowym przyłączem G 3/4" L=210 mm Single hole sink mixer with additional outflow G 3/4" Смеситель для мойки с дополнительным соединением Einloch Spültischeinhebelmischer</p>





















baterie jednouchwytowe PIRYT

single lever mixers PIRYT



Wyważone kształty, nowoczesna linia z idealnie dopasowanym uchwytem – rodzina baterii PIRYT. Greckie słowo pyrites, oznaczające iskrzący, mieniący się przedmiot ma swoje odzwierciedlenie w nieskazitelnej jakości powierzchni baterii. Delikatnie wymodelowany uchwyt baterii wyprowadzony lekkim łukiem zyskuje subtelny wygląd dzięki oryginalnej i nieszablonowej formie. Seria PIRYT idealnie harmonizuje z każdym wnętrzem.

Balanced shaped, modern line with ideally fitted handle – the PIRYT mixer family. The Greek word Pyrites, meaning glittering, chatoyant subject, reflects the quality of the mixer's surface. Finely shaped handle of the mixer with a delicate arch has a subtle appearance for its original form. The PIRYT collection ideally harmonises with every interior.

  <p>[444-040-00]</p> <p>Bateria wannowa ścienna Bath mixer Смеситель для ванны Aufputz Wannenfüll- und Brauseeinhebelmischer ohne Duschset</p>	  <p>[445-041-00]</p> <p>Bateria wannowa stojąca dwuotworowa Two-hole bath mixer Стойчий смеситель для ванны Zweiloch Wannenfüll- und Brausearmatur ohne Duschse</p>	  <p>[446-040-00]</p> <p>Bateria natryskowa ścienna Shower mixer Смеситель для душа Aufputz Brauseeinhebelmischer ohne Duschset</p>	  <p>[440-840-00 / 440-940-00]</p> <p>Bateria umywalkowa / zlewozmywakowa ścienna L=150 mm / 200 mm Wall-mounted wash basin / sink mixer Смеситель для мойки и умывальника Aufputz Wasch- und Spültischeinhebelmischer</p>
  <p>[442-845-00]</p> <p>Bateria umywalkowa stojąca Single hole wash basin mixer Смеситель для умывальника Einloch Waschtischeinhebelmischer</p>	  <p>[442-945-00]</p> <p>Bateria umywalkowa stojąca z obrotową wylewką L=145 mm Single hole wash basin mixer Смеситель для умывальника с поворотным изливом Einloch Waschtischarmatur</p>	  <p>[447-045-00]</p> <p>Bateria bidetowa stojąca Bidet mixer Смеситель для биде Einloch Bidetarmatur</p>	  <p>[443-140-00]</p> <p>Bateria zlewozmywakowa stojąca z wyciąganym natryskiem Single hole sink mixer with handshower Смеситель для мойки с выдвижным душем Einloch Spültischeinhebelmischer mit Handbrause</p>
  <p>[443-845-00]</p> <p>Bateria zlewozmywakowa stojąca z obrotową wylewką L=210 mm Single hole sink mixer Смеситель для мойки с поворотным изливом Einloch Spültischeinhebelmischer</p>			



baterie jednouchwytowe

RODON

single lever mixers RODON



Klasyczna forma baterii zbudowana na bazie prostych, równoległe ułożonych linii. Wyprofilowany korpus baterii naturalnie domyka uchwyt będący powtórzeniem jego zarysu. Baterie RODON to gwarancja estetyki na najwyższym poziomie, pełniąc zarówno funkcje estetyczne jak i użytkowe stanowią doskonały akcent w naszych łazienkach.

Classic form mixer based on straight parallel lines. Profiled corp of the mixer naturally closes the handle being the reflection of its shape. RODON mixers guarantee top level aesthetics, fulfilling both aesthetic and usable functions. Make an excellent accent in our bathrooms.



[454-020-00]

Bateria wannowa ścienna
Bath mixer
Смеситель для ванны
Aufputz Wannenfüll- und
Brauseeinhebelmischer ohne Duschset



[456-020-00]

Bateria natryskowa ścienna
Shower mixer
Смеситель для душа
Aufputz Zweigriff Brausearmatur



[450-820-00 / 450-920-00]

**Bateria umywalkowa / zlewozmywakowa
ścienna L=150 mm / L=200 mm**
Wall-mounted wash basin / sink mixer
Смеситель для мойки и умывальника
Aufputz Wasch- und
Spültischeinhebelmischer



[452-825-00]

Bateria umywalkowa stojąca
Single hole wash basin mixer
Смеситель для умывальника
Einloch Waschtischeinhebelmischer



[452-925-00]

**Bateria umywalkowa stojąca
z obrotowym wylotem L=150 mm**
Single hole wash basin mixer
Смеситель для умывальника
с поворотным изливом
Einloch Waschtischeinhebelmischer



[457-025-00]

Bateria bidetowa stojąca
Bidet mixer
Смеситель для биде
Einloch Bidetarmatur



[453-925-00]

**Bateria zlewozmywakowa stojąca
z obrotowym wylotem L=200 mm**
Single hole sink mixer
Смеситель для мойки с поворотным
изливом
Einloch Spültischeinhebelmischer

























baterie dwuuchwytowe HARMONIC

double lever mixers HARMONIC



Awangardowa rodzina baterii dwuuchwytowych. Kształt uchwytów harmonijnie współgra z bryłą baterii. Prostopadle przenikające się walce tworzą wyjątkową i charakterystyczną formę przestrzenną. Bateria dopełniająca wyrafinowane wnętrza zaspokoi najbardziej wysublimowane gusta. Pełna harmonia.

Avant-garde double handle mixer family. The shape of the handles harmoniously corresponds with the corp of the mixer. Perpendicular infiltrating cylinders make an original and characteristic spatial form. Mixer fulfilling sophisticated interiors will meet most sublime tastes. Full harmony.

  <p>[344-020-00]</p> <p>Bateria wannowa ścienna Bath mixer Смеситель для ванны Aufputz Zweigriff Wannenfüll- und Brausearmatur ohne Duschset</p>	   <p>[348-720-00]</p> <p>Bateria wannowo / umywalkowa ścienna L=350 mm Wall-mounted wash basin / bath mixer with long spout Смеситель для ванны и умывальника с длинным изливом L= 350 mm Aufputz Zweigriff Wannenfüll- und Brausearmatur ohne Duschset</p>	  <p>[345-020-00]</p> <p>Bateria wannowa stojąca Bath mixer Стоячий смеситель для ванны Zweigriff Wannenfüll- und Brausearmatur ohne Duschset</p>	  <p>[345-520-00]</p> <p>Bateria wannowa pięciootworowa stojąca Five hole bath mixer Стоячий смеситель для ванны в пяти отверстиях Stehende 5-Loch-Armatur für Badewanne</p>
  <p>[346-020-00]</p> <p>Bateria natryskowa ścienna Shower mixer Смеситель для душа Aufputz Zweigriff Brausearmatur ohne Duschset</p>	   <p>[340-820-00 / 340-920-00]</p> <p>Bateria umywalkowa / zlewozmywakowa ścienna L=150 mm / L=200 mm Wall-mounted wash basin / sink mixer Смеситель для мойки и умывальника Aufputz Wasch- und Spültischarmatur</p>	  <p>[342-325-00]</p> <p>Bateria umywalkowa stojąca Single hole wash basin Смеситель для умывальника с поворотным изливом Einloch Zweigriff Waschtischarmatur</p>	  <p>[347-025-00]</p> <p>Bateria bidetowa stojąca Bidet mixer Смеситель для биде Einloch Zweigriff Bidetarmatur</p>
  <p>[343-120-00]</p> <p>Bateria zlewozmywakowa stojąca z wyciąganym natryskiem Single hole sink mixer with handshower Смеситель для мойки с выдвижным душем Einloch Zweigriff Spültischarmatur mit Handbrause</p>	  <p>[342-420-00]</p> <p>Bateria zlewozmywakowa stojąca Single hole sink mixer Смеситель для мойки Einloch Zweigriff Spültischarmatur</p>		



baterie dwuuchwytowe SYMETRIC

























double lever mixers SYMETRIC



Rodzina SYMETRIC to propozycja nowoczesnego standardu, będącego wynikiem połączenia klasyki z elegancją minimalizmu. Doskonała symetria formy zastosowana w uchwytach, prostota i uporządkowana linia wzornicza w harmonijny sposób łączy funkcjonalność i elegancję w przystępnej cenie. Baterie SYMETRIC zostały wyróżnione nominacją do nagrody PRODECO.

The SYMETRIC family is the offer of modern standard, combination of classics with the elegance of minimalism. Excellent form symmetry applied in handles, simplicity and ordered design combines functionality and elegance in a harmonious manner at a reasonable price. SYMETRIC mixers were nominated for the PRODECO prize.

N O M I N A C J A
P R O D E C O
2007

  <p>[344-010-00] chrom [344-010-04] satyna-chrom</p> <p>Bateria wannowa ścienna Bath mixer Смеситель для ванны Zweigriff Wannenfüll- und Brausearmatur ohne Duschset</p>	  <p>[348-710-00] chrom [348-710-04] satyna-chrom</p> <p>Bateria wannowo / umywalkowa ścienna L=350 mm Wall-mounted wash basin / bath mixer with long spout Смеситель для ванны и умывальника с длинным изливом L= 350 mm Aufputz Zweigriff Wannenfüll- und Brausearmatur ohne Duschset</p>	  <p>[345-010-00] chrom [345-010-04] satyna-chrom</p> <p>Bateria wannowa stojąca Bath mixer Стойкий смеситель для ванны Aufputz Zweigriff Wannenfüll- und Brausearmatur ohne Duschset</p>	  <p>[345-510-00] chrom</p> <p>Bateria wannowa pięciootworowa Five hole bath mixer Стойкий смеситель для ванны в пяти отверстиях Stehende 5-Loch-Armatur für Badewanne</p>
  <p>[346-010-00] chrom [346-010-04] satyna-chrom</p> <p>Bateria natryskowa ścienna Shower mixer Смеситель для душа Aufputz Zweigriff Brausearmatur ohne Duschset</p>	  <p>[346-910-00] chrom</p> <p>Deszczownia DUNA z baterią natryskową SYMETRIC Rainstorm DUNA with SYMETRIC shower mixer Дождевальная установка DUNA с душевым смесителем SYMETRIC DUNA Duschanlage mit SYMETRIC Duschbatterie</p>	  <p>[340-810-00] chrom L=150 mm [340-910-00] chrom L=200 mm [340-810-04] satyna-chrom L=150 mm [340-910-04] satyna-chrom L=200 mm</p> <p>Bateria umywalkowa / zlewozmywakowa ścienna L=150 mm / L=200 mm Wall-mounted wash basin / sink mixer Смеситель для мойки и умывальника Aufputz Zweigriff Wasch- und Spültischarmatur</p>	  <p>[342-315-00] chrom [342-315-04] satyna-chrom</p> <p>Bateria umywalkowa stojąca Single hole wash basin Смеситель для умывальника с поворотным изливом Einloch Zweigriff Waschtischarmatur</p>
  <p>[347-015-00] chrom [347-015-04] satyna-chrom</p> <p>Bateria bidetowa stojąca Bidet mixer Смеситель для биде Einloch Zweigriff Bidetarmatur</p>	  <p>[343-110-00] chrom [343-110-04] satyna-chrom</p> <p>Bateria zlewozmywakowa stojąca z wyciąganym natryskiem Single hole sink mixer with handshower Смеситель для мойки с выдвижным душем Einloch Zweigriff Spültischarmatur mit Handbrause</p>	  <p>[343-210-00] chrom</p> <p>Bateria zlewozmywakowa stojąca z wyciąganą wylewką Single hole sink mixer with handshower Смеситель для мойки с выдвижным изливом Einloch Zweigriff Spültischarmatur mit Handbrause</p>	  <p>[342-410-00] chrom [342-410-04] satyna-chrom</p> <p>Bateria zlewozmywakowa stojąca Single hole sink mixer Смеситель для мойки Einloch Zweigriff Spültischarmatur</p>



baterie termostaticzne

CLASSIC/STANDARD

mixers with thermostat CLASSIC/STANDARD



Nareszcie koniec z nieoczekiwanymi zmianami temperatur. Nie musimy się już martwić o ciągłą regulację temperatury wody czy obawiać poparzenia w wyniku przypadkowego przekręcenia uchwyty baterii – co jest szczególnie istotne podczas kąpieli pod prysznicem. Oznaczona na pokrętle skala i przycisk „przeciwpoparzeniowy” umożliwiają precyzyjne ustalenie pożądanej temperatury wody.

End of the unexpected temperature changes. One doesn't have to worry about endless water temperature regulation or dread of burning due to accidental turning of the mixer handle – which is especially important during taking showers. A scale marked on the handle and the „antiburn” button allow precise setting required water temperature.



[574-012-00]

Bateria termostatyczna wannowa STANDARD
Bath mixer with thermostat
Термостатический смеситель для ванны
Aufputz Wannenfüll - und Brausethermostat ohne Duschset



[576-012-00]

Bateria termostatyczna natryskowa STANDARD
Shower mixer with thermostat
Термостатический смеситель для душа
Aufputz Brausethermostat ohne Duschset



[574-010-00]

Bateria termostatyczna wannowa CLASSIC
Bath mixer with thermostat
Термостатический смеситель для ванны
Aufputz Wannenfüll - und Brausethermostat ohne Duschset



[576-010-00]

Bateria termostatyczna natryskowa CLASSIC
Shower mixer with thermostat
Термостатический смеситель для душа
Aufputz Brausethermostat ohne Duschset



[576-910-00]

Deszczownia SOLARIS z regulacją wysokości talerza i baterią termostatyczną natryskową
Rainstorm with thermostatic wall shower mixer
Дождевальная установка SOLARIS с термостатическим смесителем
Duschanlage mit Brausethermostat



Basic Class

Przyjazne i harmonijne wnętrze nie zawsze wymaga kosztownych i ekskluzywnych produktów. Od naszej pomysłowości i kreatywności zależy jaki uzyskamy końcowy efekt. W naszej łazience mamy poczuć się wygodnie i komfortowo, a chwile w niej spędzane mają naszastrajać nas pozytywnie. Tak niewiele potrzeba by wydobyc piękno.

Friendly and harmonious interior does not always require expensive and exclusive products. Our inventiveness and creativeness leads us to the final effect. One should feel comfortable and cosy in ones bathroom and the time spent there should incline us positively. So little is needed to elicit beauty.

Basic Class

beryl – new
baryt
ceramik
standard





Nowość

baterie jednouchwytowe

BERYL

single lever mixers BERYL



Rodzina BERYL to bateria zaprojektowana w minimalistycznym stylu. Prosty uchwyt o charakterystycznej, zdecydowanej linii w sposób interesujący nadaje baterii indywidualnego charakteru. Projektanci opracowując kształt uchwyty szczególnie uwagę skierowali na ergonomię i wzornictwo. Efektem tego jest lekko podniesiona przednia część uchwyty, która sprawia, że obsługa baterii staje się wyjątkowo komfortowa.

The BERYL family – the mixer designed in minimalistic style. Simple handle with characteristic, firm line, giving an interesting individual character to the mixer. The designers stressed on ergonomics and pattern-designing while creating the handle. It resulted in a slightly upraised front part of the handle which makes operating the mixer exceptionally comfortable.



[4804-010-00]

Bateria wannowa ścienna
Bath mixer
Смеситель для ванны
Aufputz Wannenfüll- und Brausearmatur ohne Duschet



[4806-010-00]

Bateria natryskowa ścienna
Shower mixer
Смеситель для душа
Aufputz Brausearmatur ohne Duschet



[4800-810-00]

Bateria umywalkowa ścienna z wylewką L=150 mm
Wash basin mixer
Смеситель для умывальника с поворотным изливом
Aufputz Waschtischarmatur



[4800-910-00]

Bateria zlewozmywakowa ścienna z wylewką L=200 mm
Sink mixer with rotary spout
Смеситель для мойки с поворотным изливом
Aufputz Spültischarmatur



[4802-815-00]

Bateria umywalkowa stojąca
Single hole wash basin mixer
Смеситель для умывальника
Einloch Waschtischarmatur



[4802-915-00]

Bateria umywalkowa stojąca z obrotową wylewką L=200 mm
Wash basin mixer with rotary spout
Смеситель для умывальника с поворотным изливом
Einloch Waschtischarmatur



[4807-015-00]

Bateria bidetowa stojąca
Bidet mixer
Смеситель для биде
Einloch Bidetarmatur



[4803-915-00]

Bateria zlewozmywakowa stojąca z obrotową wylewką L=200 mm
Single hole sink mixer with a rotary spout
Смеситель для мойки с поворотным изливом
Einloch Spültischarmatur

















baterie jednouchwytowe BARYT

single lever mixers BARYT



Rodzina baterii BARYT to jedna z najbardziej ekonomicznych serii w ofercie Armatury Kraków. Łączy klasyczny kształt i komfort użytkowania z bardzo atrakcyjną ceną. Ze względu na niewielkie gabaryty model ten jest idealną propozycją dla właścicieli małych łazienek oraz kuchni.

The BARYT family is one of the most economic collections in the Armatura Kraków offer. It combines classic shape and comfort with a very reasonable price. For its small dimensions, this model is an ideal offer for the owners of small bathrooms and kitchens.

  <p>[554-010-00]</p> <p>Bateria wannowa ścienna Bath mixer Смеситель для ванны Aufputz Wannenfüll- und Brauseeinhebelmischer ohne Duschset</p>	  <p>[556-010-00]</p> <p>Bateria natryskowa ścienna Shower mixer Смеситель для душа Aufputz Brauseeinhebelmischer ohne Duschset</p>	  <p>[550-810-00 / 550-910-00]</p> <p>Bateria umywalkowa / zlewozmywakowa ścienna L=150 mm / L=200 mm Wall-mounted wash basin / sink mixer Смеситель для мойки и умывальника Aufputz Wasch- und Spültischeinhebelmischer</p>	  <p>[552-815-00]</p> <p>Bateria umywalkowa stojąca Single hole wash basin mixer Смеситель для умывальника Einloch Waschtischeinhebelmischer</p>
  <p>[552-915-00]</p> <p>Bateria umywalkowa stojąca z obrotowym wylotem L=150 mm Single hole wash basin mixer Смеситель для умывальника с поворотным изливом Einloch Waschtischeinhebelmischer</p>	  <p>[557-015-00]</p> <p>Bateria bidetowa stojąca Bidet mixer Смеситель для биде Einloch Bideteinhebelmischer</p>	  <p>[553-915-00]</p> <p>Bateria zlewozmywakowa stojąca z obrotowym wylotem L=240 mm Single hole sink mixer Смеситель для мойки с поворотным изливом Einloch Spültischeinhebelmischer</p>	



baterie dwuuchwytowe CERAMIK

double lever mixers CERAMIK



Baterie z rodziny CERAMIK posiadają tradycyjną formę wzorniczą, wyposażoną w nowoczesne głowice ceramiczne. Baterie umywalkowe i zlewozmywakowe ściennie wyposażone są w wylewki o średnicy 18 mm, a baterie umywalkowe i zlewozmywakowe stojące w wyloty odlewane.

The CERAMIK mixers are made with traditional design and have modern ceramic heads. The wash basin and wall mounted sink mixers have spouts of 18 mm diameter and wash basin and sink standing mixers have casted spouts.

  <p>[334-115-00]</p> <p>Bateria wannowa ścienna, wylot z perlatozem Bath mixer Смеситель для ванны Aufputz Zweigriff Wannenfüll- und Brausearmatur mit Duschset</p>	  <p>[334-112-00]</p> <p>Bateria wannowo-umywalkowa ścienna Wall-mounted wash basin / bath mixer with long spout Смеситель для ванны и умывальника с длинным изливом Aufputz Zweigriff Wannenfüll- und Brausearmatur mit Duschset</p>	  <p>[336-310-00]</p> <p>Bateria natryskowa z natryskiem przesuwnym Shower mixer with shower set Смеситель для душа с душевой стойкой Aufputz Zweigriff Brausearmatur mit Duschset</p>	  <p>[330-310-00 / 330-510-00]</p> <p>Bateria umywalkowa ścienna L=160 mm / 250 mm Wall-mounted wash basin mixer Смеситель для умывальника Aufputz Zweigriff Waschtischarmatur</p>
  <p>[330-410-00 / 330-610-00]</p> <p>Bateria zlewozmywakowa ścienna L=160 mm / 250 mm Wall-mounted sink mixer Смеситель для мойки Aufputz Zweigriff Spültischarmatur</p>	  <p>[332-815-00]</p> <p>Bateria umywalkowa stojąca Single hole wash basin mixer Смеситель для умывальника Einloch Zweigriff Waschtischarmatur</p>	  <p>[337-015-00]</p> <p>Bateria bidetowa stojąca Bidet mixer Смеситель для биде Einloch Zweigriff Bidetarmatur</p>	  <p>[333-915-00]</p> <p>Bateria zlewozmywakowa stojąca Single hole sink mixer Смеситель для мойки Einloch Zweigriff Spültischarmatur</p>



baterie dwuuchwytowe STANDARD

double lever mixers STANDARD



Najpopularniejsze baterie w polskich łazienkach. Tradycyjna forma oraz sprawdzona jakość gwarantują satysfakcję użytkownika. Atrakcyjna cena wraz z niezawodnością baterii stanowią znakomite połączenie. Klienci otrzymują do wyboru cztery rodzaje uchwytów.

The most popular mixers in Polish bathrooms. A traditional form and confirmed quality guarantee satisfaction. Reasonable price followed by reliability make an excellent combination. Clients may choose out of four types of handles.

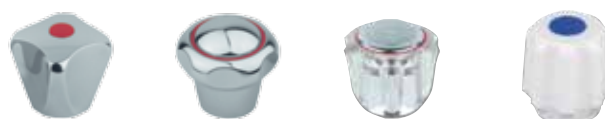

  <p>[304-120-00]</p> <p>Bateria wannowa ścienna, wylot z perlatozem Bath mixer Смеситель для ванны Aufputz Zweigriff Wannenfüll- und Brausearmatur mit Duschset</p>	  <p>[304-251-00]</p> <p>Bateria wannowa ścienna Bath mixer Смеситель для ванны Aufputz Zweigriff Wannenfüll- und Brausearmatur mit Duschset</p>	   <p>[304-118-00]</p> <p>Bateria wannowo-umywalkowa ścienna Wall-mounted wash basin / bath mixer with long spout Смеситель для ванны и умывальника с длинным изливом Aufputz Zweigriff Wannenfüll- und Brausearmatur mit Duschset</p>	  <p>[305-312-00]</p> <p>Bateria wannowa stojąca z natryskiem przesuwnym Two-hole bath mixer with shower set Стойкий смеситель для ванны с передвижным душем Zweiloch Wannenfüll- und Brausearmatur mit Duschset</p>
  <p>[306-311-00]</p> <p>Bateria natryskowa z natryskiem przesuwnym Shower mixer with shower set Смеситель для душа с передвижным душем Aufputz Zweigriff Brausearmatur mit Duschset</p>	  <p>[306-710-00]</p> <p>Bateria natryskowa z natryskiem stałym Shower mixer with shower pipe Смеситель для душа со стационарным душем Aufputz Zweigriff Brausearmatur mit Duschset</p>	  <p>[300-110-00 / 300-310-00 / 300-510-00]</p> <p>Bateria umywalkowa ścienna L=115 mm / L=160 mm / L=220 mm Wash basin mixer Смеситель для умывальника Aufputz Zweigriff Waschtischarmatur</p>	  <p>[300-210-00 / 300-410-00 / 300-610-00]</p> <p>Bateria zlewozmywakowa ścienna L=115 mm / L=160 mm / L=250 mm Wall-mounted sink mixer Смеситель для мойки Aufputz Zweigriff Spültischarmatur</p>
   <p>[300-319-00]</p> <p>Bateria umywalkowa z dodatkowym wypływem G 3/4" Wash basin mixer / sink mixer with additional out flow G 3/4" Смеситель для мойки и умывальника Aufputz Zweigriff Waschtischarmatur</p>	   <p>[301-310-00 / 301-510-00]</p> <p>Bateria umywalkowa / zlewozmywakowa stojąca dwuotworowa L=160 mm / L=200 mm Two-hole wash basin mixer / sink mixer Смеситель для мойки и умывальника Zweiloch Zweigriff Wasch- und Spültischarmatur</p>	   <p>[302-315-00 / 303-415-00]</p> <p>Bateria umywalkowa / zlewozmywakowa stojąca L=135 mm / L=185 mm Wash basin mixer / sink mixer Смеситель для мойки и умывальника Einloch Zweigriff Wasch- und Spültischarmatur</p>	  <p>[307-015-00]</p> <p>Bateria bidetowa stojąca Bidet mixer Смеситель для биде Einloch Zweigriff Bidetarmatur</p>



Baterie specjalne

Baterie specjalne to odpowiedź na specyficzne wymagania stawiane urządzeniom stosowanym w szpitalach oraz obiektach użyteczności publicznej. Bezwzględne zachowanie zasad aseptyki, łatwość użycia oraz niezawodności to cechy baterii lekarskich. Specjalnie skonstruowany wydłużony uchwyt umożliwia obsługę baterii bez zbędnego dotykania jej dłonią. Z kolei zastosowane w bateriach bezdotykowych fotokomórki to gwarancja higieny oraz dbałość o środowisko poprzez wbudowany system oszczędnościowy wody.

Special mixers are designed to answer specific requirements for devices applied in hospitals and public places. Keeping strict rules of asepsis, easy operation and reliability characterise medical mixers. Specially designed elongated handle enables using the mixer without touching it. Furthermore, the photocell applied in touch free mixers guarantee hygiene and is environmentally friendly due to a built-in water saving system.











Baterie specjalne



Baterie specjalne

[472-885-00]

Bateria umywalkowa stojąca
Single hole wash basin mixer
Смеситель для умывальника
Einloch Waschtischeinhebelmischer

  <p>[592-000-00]</p> <p>Bateria umywalkowa bezdotykowa stojąca Non-contact mixer Бесконтактный смеситель с фотоэлементом Stehende Armatur, kontaktlose Bedienung</p>	  <p>[592-110-00]</p> <p>Bateria umywalkowa bezdotykowa stojąca Non-contact mixer Бесконтактный смеситель с фотоэлементом Stehende Armatur, kontaktlose Bedienung</p>	  <p>[592-100-00]</p> <p>Bateria umywalkowa bezdotykowa stojąca Non-contact mixer Бесконтактный смеситель с фотоэлементом Stehende Armatur, kontaktlose Bedienung</p>	   <p>[470-880-00 / 470-980-00]</p> <p>Bateria umywalkowa / zlewozmywakowa ścienna L=150 mm / L=200 mm Wall-mounted wash basin / sink mixer Смеситель для мойки и умывальника Aufputz Wasch- und Spültischeinhebelmischer</p>
  <p>[472-885-00]</p> <p>Bateria umywalkowa stojąca Single hole wash basin mixer Смеситель для умывальника Einloch Waschtischeinhebelmischer</p>	  <p>[472-985-00]</p> <p>Bateria umywalkowa stojąca z obrotowym wylotem L=150 mm Single hole wash basin mixer Смеситель для умывальника с поворотным изливом Einloch Waschtischeinhebelmischer</p>	  <p>[473-985-00]</p> <p>Bateria zlewozmywakowa stojąca z obrotowym wylotem L=210 mm Single hole sink mixer Смеситель для мойки с поворотным изливом Einloch Spültischeinhebelmischer</p>	





Natryski

Wybierz swój sposób na relaks pod prysznicem. Bogata oferta natrysków Armatury Kraków to ergonomiczne i zróżnicowane kształty, praktyczne rozwiązania z systemami zapobiegającymi odkładaniu się kamienia oraz gwarancja najwyższej jakości.

Choose your way for relaxation in the shower. Wide offer of showers by Armatura Kraków are the ergonomic and various shapes, practical solutions and anti scale systems with the high quality guarantee.



Natryski

natryski przesuwne
natryski punktowe
rączki natryskowe
węże natryskowe



Natryski | SOLARIS

[841-192-00]

Deszczownia SOLARIS
Rainstorm SOLARIS
Дождевальная установка SOLARIS
SOLARIS Duschanlage



natryski przesuwne

sliding showers



Odkryj prawdziwą radość kąpieli. Poczuj krople deszczu nie wychodząc z domu. Różnorodność form, kształtów oraz funkcji dostarczą niezapomnianych chwil pod prysznicem. Pielęgnuj ciało, rozbudzaj zmysły z zestawami natryskowymi Armatury Kraków.

Discover real joy of a bath. Feel rain drops without leaving your home. Various forms, shapes and functions provide unforgettable moments under the shower. Care for your body, arouse your senses with shower sets by Armatura Kraków.

DESZCZOWNIA



[841-192-00] chrom

Deszczownia SOLARIS
z regulowaną wysokością talerza
Rainstorm SOLARIS
Дождевальная установка SOLARIS
SOLARIS Duschanlage



DESZCZOWNIA



[841-190-00] chrom

Deszczownia DUNA
Rainstorm DUNA
Дождевальная установка DUNA
DUNA Duschanlage



Nowość



[841-355-00] chrom

Natrysk przesuwny TALIA
Sliding shower
Передвижной душ
Duschset mit Stange

Nowość



[841-350-00] chrom

Natrysk przesuwny METIS
Sliding shower
Передвижной душ
Duschset mit Stange

Nowość



[841-170-00] chrom

Natrysk przesuwny CALIPSO
Sliding shower
Передвижной душ
Duschset mit Stange



[841-325-00] chrom

Natrysk przesuwny MARS
Sliding shower
Передвижной душ
Duschset mit Stange





[841-180-00] chrom

Natrysk przesuwny JUNO
Sliding shower
Передвижной душ
Duschset mit Stange



[841-310-00] chrom

Natrysk przesuwny SATURN
Sliding shower
Передвижной душ
Duschset mit Stange



[841-160-00] chrom

Natrysk przesuwny VESTA
Sliding shower
Передвижной душ
Duschset mit Stange



[841-150-00] chrom

Natrysk przesuwny IRIS
Sliding shower
Передвижной душ
Duschset mit Stange



[841-140-00] chrom
[841-140-04] satyna-chrom

Natrysk przesuwny SYMETRIC
Sliding shower
Передвижной душ
Duschset mit Stange



[841-308-00] chrom

Natrysk przesuwny NEPTUN
Sliding shower
Передвижной душ
Duschset mit Stange





[841-330-00] chrom

Natrysk przesuwny PALLAS
Sliding shower
Передвижной душ
Duschset mit Stange



[841-324-00] chrom
[841-324-04] satynowy

Natrysk przesuwny JUPITER
Sliding shower
Передвижной душ
Duschset mit Stange



[841-340-00] chrom

Natrysk przesuwny TYTAN
Sliding shower
Передвижной душ
Duschset mit Stange



[841-123-00] chrom
[841-123-03] chrom-złoto

Natrysk przesuwny WMS
Sliding shower
Передвижной душ
Duschset mit Stange



[841-322-00] chrom
[841-322-05] patyna

Natrysk przesuwny RETRO CLASSIC
Sliding shower
Передвижной душ
Duschset mit Stange



[841-111-00] chrom
[841-111-03] chrom-złoto

Natrysk przesuwny RETRO
Sliding shower
Передвижной душ
Duschset mit Stange





natryski punktowe

point fixed showers



Oferta natrysków punktowych została przygotowana dla użytkowników, którzy w swojej łazience cenią prostotę oraz solidność wykonania połączone z ekonomiczną ceną. Natryski punktowe oferowane są w siedmiu liniach różniących się między sobą oryginalnymi mocowaniami i rączkami natryskowymi. Idealnie sprawdzają się w małych łazienkach w komplecie z bateriami wannowymi.

The offer of point fixed showers has been prepared for clients who appreciate simplicity in their bathroom as well as reliability accompanied by a reasonable price. Point fixed showers are offered in seven lines, each with different original fasteners and shower handles. Ideal for small bathrooms in line with bathtub mixers.

Nowość



[841-207-00] chrom

Natrysk punktowy EOS
Rotary point shower
Точечный вращательный душ
Duschset ohne Stange



[841-210-00] chrom

Natrysk punktowy SYMETRIC
Rotary point shower
Точечный душ
Duschset ohne Stange



[841-201-00] chrom

Natrysk punktowy przegubowy z rączką REA
Articulated point shower
Точечный шарнирный душ
Duschset ohne Stange



[841-204-00] chrom

Natrysk punktowy obrotowy z rączką REA
Rotary point shower
Точечный вращательный душ
Duschset ohne Stange



[841-202-00] chrom

Natrysk punktowy przegubowy z rączką ECHO
Articulated point shower
Точечный шарнирный душ
Duschset ohne Stange



[841-203-00] chrom

Natrysk punktowy obrotowy z rączką ECHO
Rotary point shower
Точечный вращательный душ
Duschset ohne Stange



[841-206-00] chrom
[841-206-04] satyna-chrom

Natrysk punktowy obrotowy JUPITER
Rotary point shower
Точечный вращательный душ
Duschset ohne Stange



[841-209-00-BL] chrom

Natrysk punktowy (blistrowany)
Rotary point shower
Точечный душ
Duschset ohne Stange



rączki natryskowe

shower handles



Szeroka gama rączek natryskowych Armatury Kraków daje poczucie pełnej satysfakcji użytkownika. Różnorodność modeli umożliwia dopasowanie natrysku do stylu, w jakim urządzona jest nasza łazienka.

A wide range of shower handles of Armatura Kraków provides full satisfaction. Models variability enables choosing the shower according to the style of ones bathroom.



[842-019-00]

**Rączka natrysku
JOWISZ**
Shower handle
Душевая лейка
Duschkopf



[842-023-00]

**Rączka natrysku
MARS**
Shower handle
Душевая лейка
Duschkopf



[842-020-00]

**Rączka natrysku
SATURN**
Shower handle
Душевая лейка
Duschkopf



[842-026-00]

**Rączka natrysku
baterii 3-otworowej**
Shower handle
Душевая лейка
Duschkopf



[842-033-00]

**Rączka natrysku
TYTAN**
Shower handle
Душевая лейка
Duschkopf



[842-029-00]

**Rączka natrysku
VESTA**
Shower handle
Душевая лейка
Duschkopf



[842-032-00]

**Rączka natrysku
PALLAS**
Shower handle
Душевая лейка
Duschkopf



[842-025-00]

**Rączka natrysku
SYMETRIC**
Shower handle
Душевая лейка
Duschkopf



[842-035-00]

**Rączka natrysku
TALIA**
Shower handle
Душевая лейка
Duschkopf



[842-036-00]

**Rączka natrysku
REA**
Shower handle
Душевая лейка
Duschkopf





















[842-015-00] chrom-biały
[842-015-05] patyna-biały
[842-015-38] złoto-biały

**Rączka natrysku
RETRO CLASSIC**
Shower handle
Душевая лейка
Duschkopf



[842-005-08] chrom-biały
[842-005-38] złoto-biały

**Rączka natrysku
RETRO**
Shower handle
Душевая лейка
Duschkopf

  <p>[842-031-00]</p> <p>Rączka natrysku JUNO Shower handle Душевая лейка Duschkopf</p>	  <p>[842-028-00]</p> <p>Rączka natrysku IRIS Shower handle Душевая лейка Duschkopf</p>	  <p>[842-022-00]</p> <p>Rączka natrysku JUPITER Shower handle Душевая лейка Duschkopf</p>	  <p>[842-037-00]</p> <p>Rączka natrysku ECHO Shower handle Душевая лейка Duschkopf</p>
  <p>[842-034-00]</p> <p>Rączka natrysku METIS Shower handle Душевая лейка Duschkopf</p>	  <p>[842-002-44]</p> <p>Rączka natrysku z tworzywa RT Shower handle Душевая лейка Duschkopf</p>	  <p>[842-024-00] do CYRKON, SYMETRIC, HARMONIC</p> <p>Rączka do baterii kuchennych Handle for kitchen mixers Лейка для кухонных смесителей Halter für Spültischarmatur</p>	  <p>[842-038-00]</p> <p>Rączka do baterii kuchennych Handle for kitchen mixers Лейка для кухонных смесителей Halter für Spültischarmatur</p>
 <p>[842-021-00] chrom [842-021-04] satyna</p> <p>Rączka do baterii kuchennych Handle for kitchen mixers Лейка для кухонных смесителей Halter für Spültischarmatur</p>	 <p>[842-018-00] do NEFRYT</p> <p>Rączka do baterii umywalkowych Handle for kitchen mixers Лейка к смесителю для умывальника с выдвижным изливом Halter für Spültischarmatur</p>		

wężę natryskowe

shower hoses

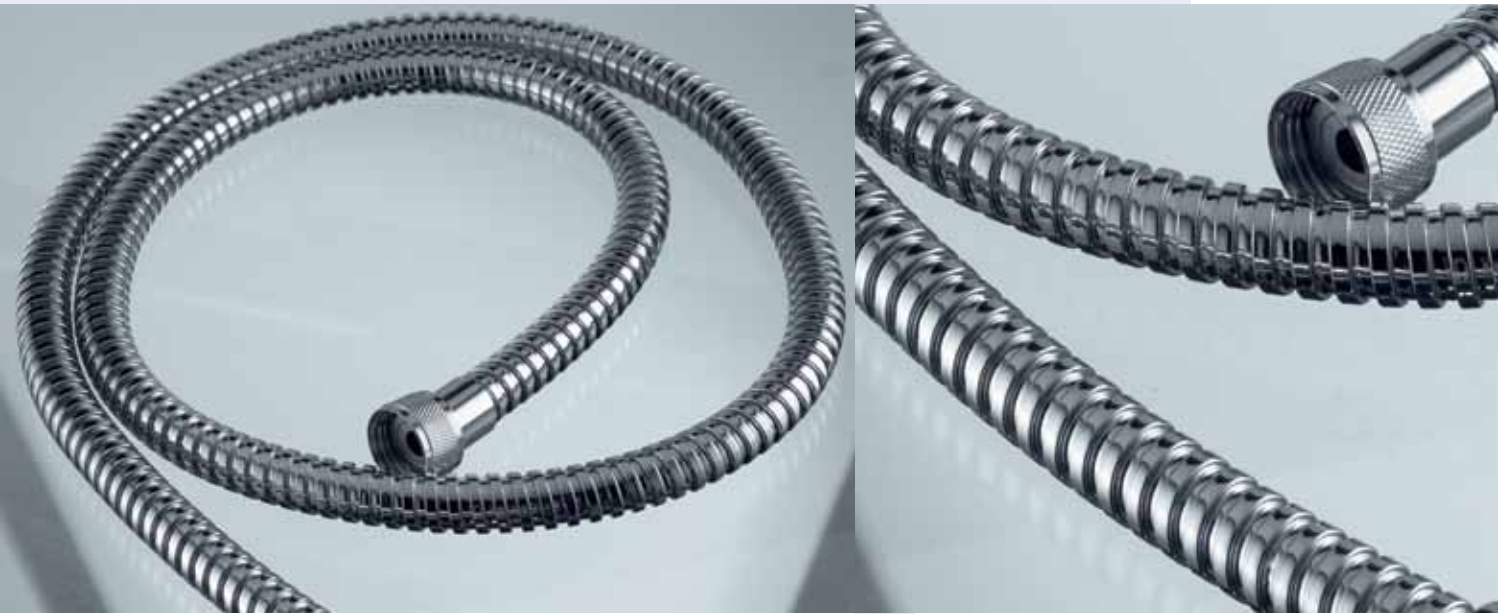

Wężę natryskowe stanowią integralny element umożliwiający korzystanie z natrysku. Oferta obejmuje między innymi wężę natryskowe z tworzywa w oplocie mosiężnym o podwyższonej wytrzymałości na rozciąganie. Specjalny oplót węża podnosi jego wartość użytkową i nadaje charakterystyczny wygląd.

Shower hoses make an integral element enabling using the shower. Our offer comprises of plastic shower hoses with brass braid with increased tensile strength. Special hose braid improves its value in use and gives it characteristic appearance.

Pełna oferta produktów znajduje się w cenniku Grupy Armatura oraz na stronie www.grupa-armatura.pl

Full range of products you can find in the Collection Catalogue of Armatura Group as well as on the website www.grupa-armatura.pl



[843-012-00]

Wąż natryskowy metalowy L=1400 mm
Metal shower hose
Шланг душевой металлический
Metallduschenschlauch



[843-113-00]

Wąż natryskowy stożkowy metalowy L=1600 mm
Metal shower hose with a cone
Шланг душевой металлический с конусом
Metallduschenschlauch mit Kegel

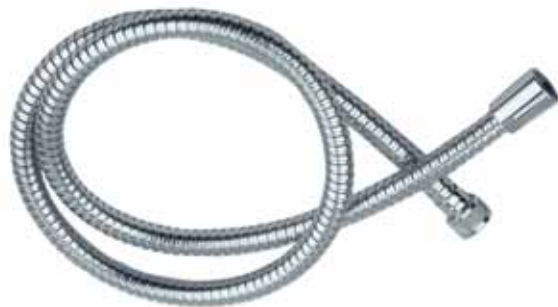

[843-101-44]

Wąż natryskowy z tworzywa L=1600 mm
Plastic shower hose
Шланг душевой пластмассовый
Kunststoffduschenschlauch





[843-105-86]

Wąż do baterii kuchennej nylonowy
Nylon kitchen shower hose
Шланг кухонный душевой нейлоновый
Nylonküchenduschienschlauch

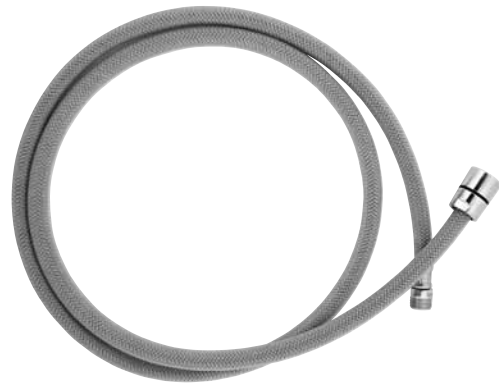

[843-161-00]

Wąż do baterii kuchennej metalowy, agrafkowy
Metal kitchen shower hose
Шланг кухонный душевой металлический
Metallküchenduschienschlauch

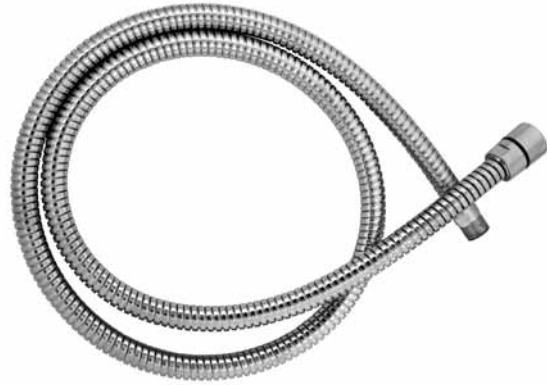



Aksesoria

Tak samo, jak ważne jest jaki rodzaj baterii dobierzemy do naszej łazienki, ważne jest jakie zastosujemy akcesoria uzupełniające. O efekcie końcowym niejednokrotnie decydują drobne detale.

Choosing accessories is important as choosing the type of faucet for ones bathroom. The final effect is often determined by small details.

Akcesoria:

Syfony i spusty

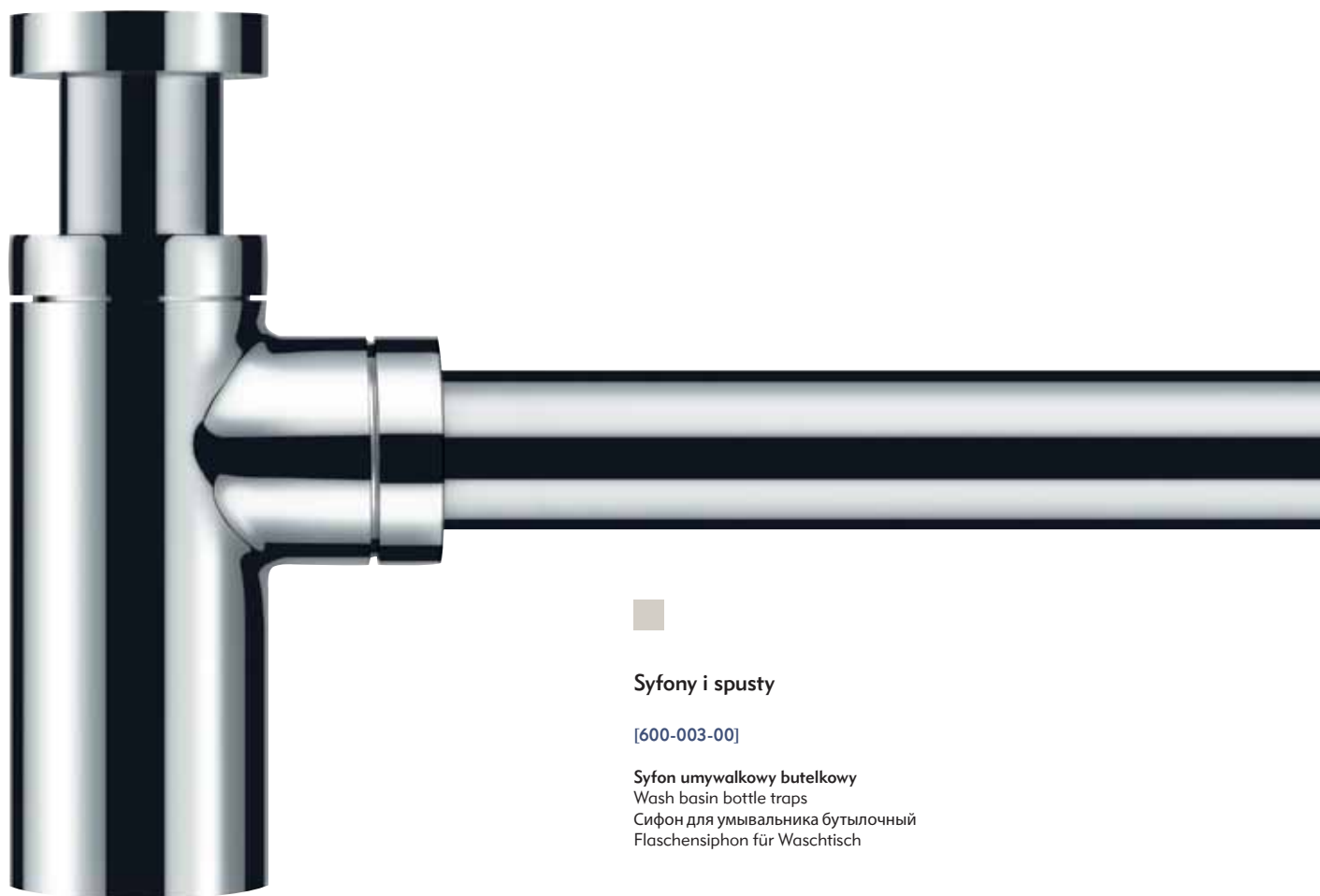

Syfony i spusty

[600-003-00]

Syfon umywalkowy butelkowy
Wash basin bottle traps
Сифон для умывальника бутылочный
Flaschensiphon für Waschtisch











syfony i spusty

siphons and spouts



Odpowiednio dobrane detale mają wpływ na styl i charakter wnętrza. Syfony i spusty do nowoczesnych baterii umywalkowych są uzupełnieniem grupy Premium Class.

Properly chosen details influence the style and character of the interior. Siphons and spouts for modern wash basins make the supplement for the Premium Class group.

 <p>[600-003-00]</p> <p>Syfon umywalkowy butelkowy Wash basin bottle traps Сифон для умывальника бутылочный Flaschensiphon für Waschtisch</p> 	 <p>[600-002-00]</p> <p>Syfon umywalkowy butelkowy Wash basin bottle traps Сифон для умывальника бутылочный Flaschensiphon für Waschtisch</p> 	 <p>[600-001-00]</p> <p>Syfon umywalkowy butelkowy Wash basin bottle traps Сифон для умывальника бутылочный Flaschensiphon für Waschtisch</p> 	 <p>[604-454-00 / 604-454-05]</p> <p>Syfon rurowy Wash basin pipe traps Сифон трубный Rohrsiphon</p>
 <p>[601-054-00]</p> <p>Syfon butelkowy Bottle traps Сифон бутылочный Flaschensiphon</p>	 <p>[602-355-44] białe tworzywo spust metalowy [602-255-44] białe tworzywo spust z tworzywa</p> <p>Syfon umywalkowy z tworzywa Wash basin traps Сифон для умывальника пластмассовый Waschtischsiphon aus Kunststoff</p>	 <p>[620-010-44]</p> <p>Syfon pisuarowy z tworzywa PVC urinal traps Сифон для писсуара пластмассовый Urinalsiphon aus Kunststoff</p>	 <p>[660-454-00]</p> <p>Spust KLIK-KLAK „kwadrat“ KLIK-KLAK metal traps Выпуск полуавтомат квадратный KLIK-KLAK-Abfluss</p>
 <p>[660-254-00]</p> <p>Spust KLIK-KLAK „duży“ KLIK-KLAK metal traps „large“ Выпуск полу-автомат «большой» KLIK-KLAK-Abfluss, „groß“</p>	 <p>[660-354-00]</p> <p>Spust KLIK-KLAK „mały“ KLIK-KLAK metal traps „small“ Выпуск полу-автомат «маленький» KLIK-KLAK-Abfluss, „klein“</p>	 <p>[660-054-00]</p> <p>Spust sterowany do baterii stojących Regulated bottom trap Донный клапан со спицей для бортовых смесителей Gesteuerter Abfluss für stehende Armaturen</p>	

Armatura sanitarna



Armatura wodna i gazowa



Grzejniki i armatura
centralnego ogrzewania

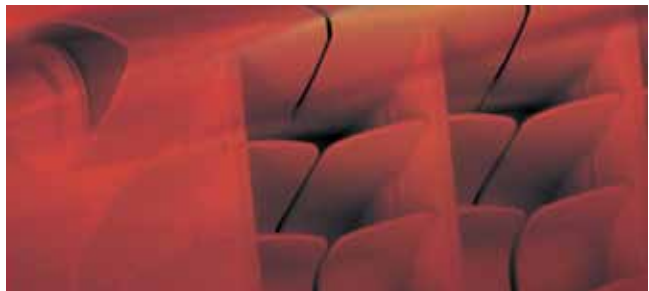

- Zawory wypływowe 104
- Zawory kątowe 108
- Zawory kulowe 111
- Zawory gazowe 115
- Przyłącza do gazu 118

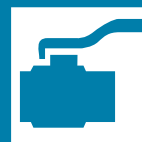

s. 100 – 119







zawory wypływowe

discharge valves



To gama produktów umożliwiających pobieranie wody, o szerokim spektrum zastosowania w domu, ogrodzie oraz pomieszczeniach gospodarczych. W grupie zaworów znajdziemy produkty posiadające funkcję czasowego zamykania wypływu wody, przeznaczone do umywalk, pisuarów i natrysków.

It is a range of products for water consumption with a wide spectrum of application in a house, garden and utility rooms. This group of valves consists of products with automatic water flow regulator designed for wash basins, urinals and showers.





[181-000-00]

Zawór z otwarciem czasowym do umywalki oszczędnościowy
Timed outlet wash basin tap
Кран дозатор для умывальника
Ventil mit zeitlicher Öffnung für Waschtisch

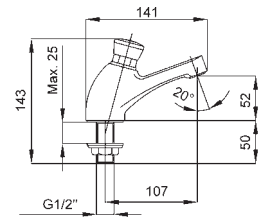

wymiar	opakowanie jednost.	opakowanie zbiorcze	rodzaje uchwytów
1/2"	1	5	-

[183-000-00]

Zawór z otwarciem czasowym do pisuaru oszczędnościowy
Timed outlet urinal valve
Кран дозатор для писсуара
Ventil mit zeitlicher Öffnung für Urinal

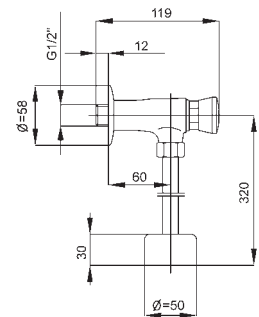

wymiar	opakowanie jednost.	opakowanie zbiorcze	rodzaje uchwytów
1/2"	1	5	-



[182-000-00]

Zawór podtynkowy, natryskowy z otwarciem czasowym
Timed build-in shower valve
Кран дозатор скрытого монтажа
Ventil mit zeitlicher Öffnung für Dusche

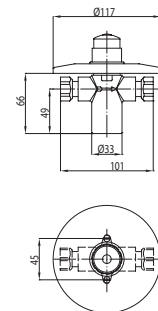

wymiar	opakowanie jednost.	opakowanie zbiorcze	rodzaje uchwytów
1/2"	1	30	-



[200-110-00]

Zawór ścienny 1/2" z napowietrzaczem, długość L=85 mm
Elongated bibtap
Кран для умывальника 1/2"
Waschtischventil mit Belüftung

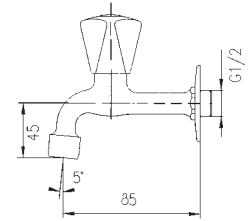

wymiar	opakowanie jednost.	opakowanie zbiorcze	rodzaje uchwytów
1/2"	1	10	-



[100-312-00]

Zawór ścienny 1/2", długość L=80 mm
Bibtap
Выпускной кран 1/2"
Wandausströmventil

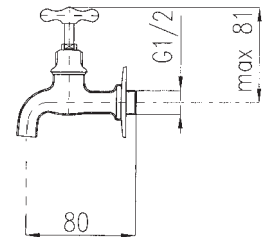

wymiar	opakowanie jednost.	opakowanie zbiorcze	rodzaje uchwytów
1/2"	1	10	-



[110-312-00]

Zawór ścienny 1/2", złączka do węża G 3/4"
długość L=80 mm
Bibtap with hose connection
Выпускной кран 1/2"
Ausströmventil mit Schlauchmuffe

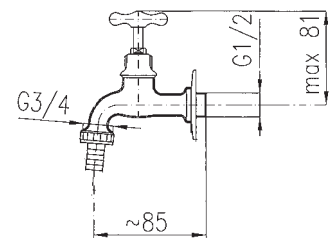

wymiar	opakowanie jednost.	opakowanie zbiorcze	rodzaje uchwytów
1/2"	1	10	-



[190-112-07]

Zawór z szybkozłączką, korpus żeliwny

Valve with quick connect coupling, iron cast corp

Кран для полива с быстросоединителем, корпус чугунный

Ventil mit Schnellmuffe, Gehäuse aus Gusseisen

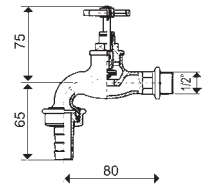

wymiar	opakowanie jednost.	opakowanie zbiorcze	rodzaje uchwytów
1/2"	15	60	-



zawory kątowe

angle valves



Zawory kątowe są przeznaczone do podłączenia spłuczek, zmywarek, pralek. Wyróżniają się atrakcyjnym wzornictwem dopasowanym do wyglądu baterii. Stanowią niewielki detal w naszej łazience istotnie wpływający na jej wygląd.

The angle valves are designed for connecting toilet tanks, dishwashers and washing machines. Their attractive design is adjusted to the mixer appearance. It is a small detail in ones bathroom significantly influencing its appearance.





[244-010-00]
[244-110-00]

Zawór kątowy do baterii stojących „belka”
Angle valve „bar”
Угловой кран для стоячих смесителей
Eckventil für stehende Armaturen

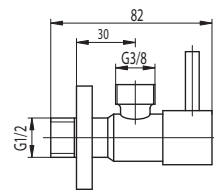
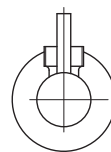

indeks	wymiar	opakowanie jednost.	opakowanie zbiorcze
[244-010-00]	1/2"x3/8"	1	10
[244-110-00]	1/2"x3/4"		



[244-020-00]
[244-120-00]

Zawór kątowy do baterii stojących „kwadrat”
Angle valve „square”
Угловой кран для стоячих смесителей
Eckventil für stehende Armaturen

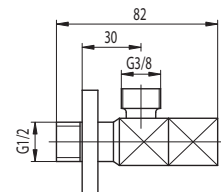
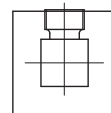

indeks	wymiar	opakowanie jednost.	opakowanie zbiorcze
[244-020-00]	1/2"x3/8"	1	10
[244-120-00]	1/2"x3/4"		



[244-030-00]
[244-130-00]

Zawór kątowy do baterii stojących „symetric”
Angle valve „symetric”
Угловой кран для стоячих смесителей
Eckventil für stehende Armaturen

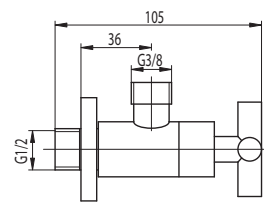
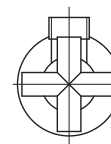

indeks	wymiar	opakowanie jednost.	opakowanie zbiorcze
[244-030-00]	1/2"x3/8"	1	10
[244-130-00]	1/2"x3/4"		





[244-040-00]
[244-140-00]

Zawór kątowy do baterii stojących „walec”
Angle valve „cylinder”
Угловой кран для стоячих смесителей
Eckventil für stehende Armaturen

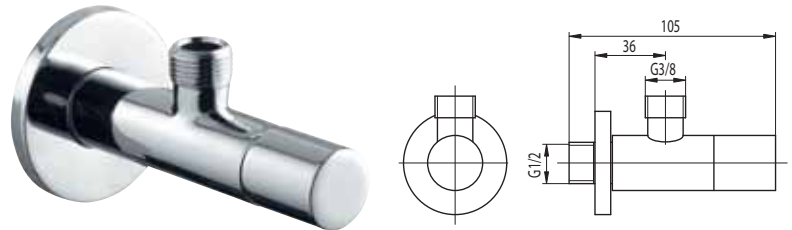

indeks	wymiar	opakowanie jednost.	opakowanie zbiorcze
[244-040-00]	1/2"x3/8"	1	10
[244-140-00]	1/2"x3/4"		



[270-000-00]
[274-000-00]

Zawór kątowy RETRO
Angle valve RETRO
Угловой кран
Eckventil



indeks	wymiar	opakowanie jednost.	opakowanie zbiorcze
[270-000-00]	1/2"x3/4"	1	5
[274-000-00]	1/2"x1/2"		

zawory kulowe

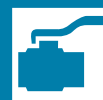

ball valves



Zawory przeznaczone są do instalacji wody zimnej i ciepłej, stanowią niezbędną część każdej instalacji będąc głównym elementem sterującym i odcinającym przepływ mediów. Kluczową sprawą jest prawidłowy dobór typu i wymiarów zaworu kulowego z uwzględnieniem rodzaju i czynnika roboczego w instalacji oraz granicznymi parametrami pracy.

The ball valves for cold and hot water installation are the necessary element of each water system as the main control and cut off element. The key aspect is proper selection of types and dimensions of ball valves with consideration to the operation factor type and limiting operation parameters.



Pełna oferta produktów znajduje się w cenniku Grupy Armatura oraz na stronie www.grupa-armatura.pl

Full range of products you can find in the Collection Catalogue of Armatura Group as well as on the website www.grupa-armatura.pl

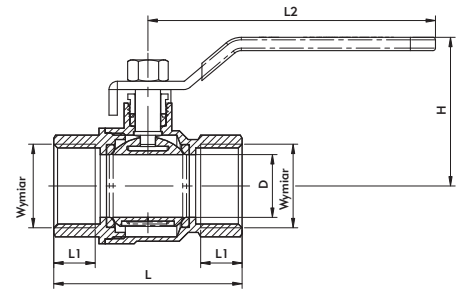

[700-110-15]

Zawór kulowy pełnoprzepływowy nakrętno-nakrętny z dźwignią, z dławikiem

Full bore ball valve FF
Шаровой кран полнопроходной наружн.-наружн. с рычагом Durchgangs-Wasser-Kugelventil aufschraubbar-aufschraubbar

indeks	wymiar	D	L	L1	L2	H	PN	waga [g]	opakow. jednost.	opakow. zbiorcze
[700-110-15]	1/2"	15	57	13,5	84,5	45,5	16	198	20	100

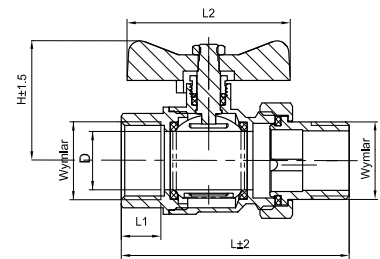

[700-221-15]

Zawór kulowy pełnoprzepływowy nakrętno-wkrętny ze śrubunkiem, z dławikiem i motylkiem

Full bore ball valve with tail and butterfly handle
Шаровой кран полнопроходной наружно-внутренний с бабочкой Volldurchflusskugelventil zum Aufdrehen/Eindreihen mit Verschraubung und Falter

indeks	wymiar	D	L	L1	L2	H	PN	waga [g]	opakow. jednost.	opakow. zbiorcze
[700-221-15]	1/2"	15	76,5	13,5	54	37	16	226	16	80

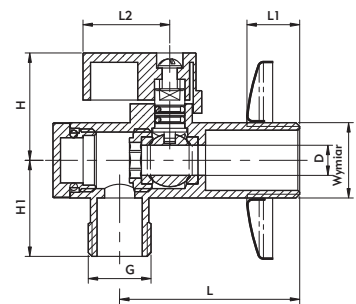

[707-010-10]

Zawór kulowy kątowy z dźwignią i z filtrem

Angle ball valve with filter
Шаровой кран угловой с фильтром и отражателем Kugel-Eckventil mit Filter und Rosette

indeks	wymiar	D	L	L1	L2	H	H1	PN	waga [g]	opakow. jednost.	opakow. zbiorcze
[707-010-10]	1/2"x3/8"	8	47,8	14	23	28,5	25,5	10	105	1	120

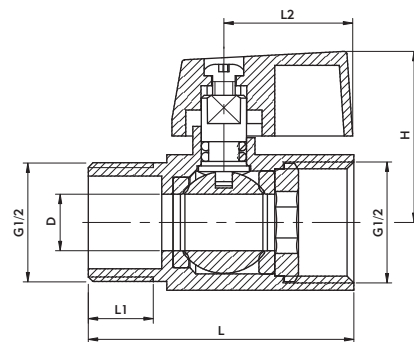

[703-210-15]

Zawór kulowy „mini” nakrętno-wkrętny z dźwignią
 Mini ball valve FF
 Шаровой кран «мини» наружн.-внутр.
 Drossel-Reduzier-Kugel-Wasserventil aufschraubbar-einschraubba

indeks	wymiar	D	L	L1	L2	H	PN	waga [g]	opakow. jednost.	opakow. zbiorcze
[703-210-15]	1/2"	10	47	10	22,8	30	10	113	50	250

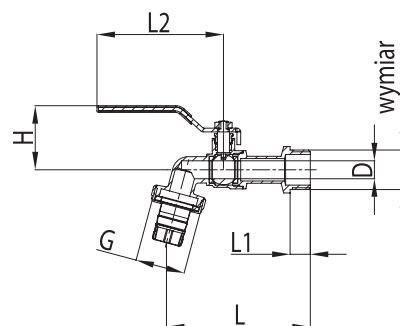

[704-010-15]

Zawór kulowy czerpalny ze złączką węża i dźwignią, z dławikiem
 BIBCOCK
 Шаровой кран для полива с рычагом и шланговым соединителем
 Zapf-Wasser-Kugelventil mit Hebel und Nippel

indeks	wymiar	D	L	L1	L2	H	PN	waga [g]	opakow. jednost.	opakow. zbiorcze
[704-010-15]	1/2"	11	88	11	84,5	39,5	16	172	20	100

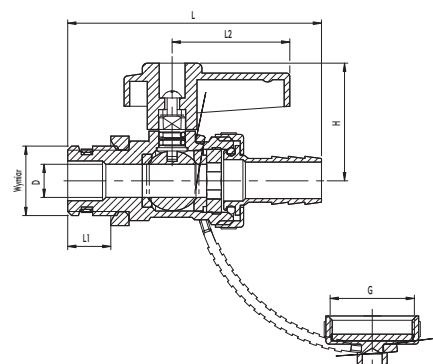

[705-010-15]

Zawór kulowy spustowy ze złączką, zaślepką i z dźwignią
 BOILER VALVE
 Шаровой кран сливной с шланговым соединителем и заглушкой
 Abfaß-Wasser-Kugelventil mit Nippel und Blende

indeks	wymiar	D	L	L1	L2	G	PN	waga [g]	opakow. jednost.	opakow. zbiorcze
[705-010-15]	1/2"	10	76	13	35,5	3/4"	16	199	20	100

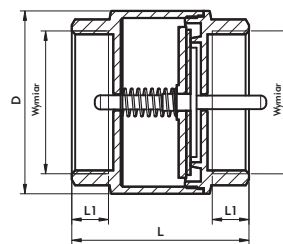

[710-010-15]

Zawór zwrotny z mosiężnym grzybkiem
 Check valve with spring
 Обратный клапан.
 Wasser-Rückschlagventil mit Feder
 - aus Messing

indeks	wymiar	D	L	L1	PN	waga [g]	opakow. jednost.	opakow. zbiorcze
[710-010-15]	1/2"	33	45	12	16	120	50	300

zawory gazowe

valves for gas installation

Nowość



Zawór gazowy jest jednym z najistotniejszych elementów sieci instalacyjnej. Od jego niezawodności i szczelności zależy prawidłowy przepływ gazu. Ma on także kluczowe znaczenie dla bezpieczeństwa danego obiektu, gdyż pozwala na szybkie odcięcie gazu w sytuacji awaryjnej. Decydując się na wybór tak ważnego elementu instalacji, należy brać pod uwagę tylko produkty najwyższej jakości.

The gas valve is one of the most important elements in the installation. Its reliability and leak proof is crucial for proper gas flow. It is also the key element for safety since it provides the possibility of quick gas closing in a malfunction. Choosing such important accessories only top quality products should be considered.



Pełna oferta produktów znajduje się w cenniku Grupy Armatura oraz na stronie www.grupa-armatura.pl

Full range of products you can find in the Collection Catalogue of Armatura Group as well as on the website www.grupa-armatura.pl

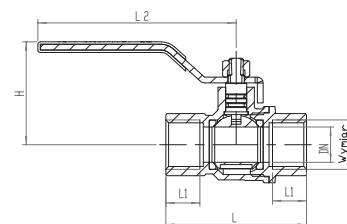

[730-110-10]

Kurek kulowy do gazu nakrętno-nakrętny z dźwignią
 Valve for gas installation female-female with lever
 Шаровой кран наружн. – наружн. с рычагом
 Gaskugelhahn zum Außengewinde/Außengewinden mit Hebel

indeks	wymiar	D	L	L1	L2	H	PN	waga [g]	opakow. jednost.	opakow. zbiorcze
[730-110-10]	Rp 3/8"	10	52	13,5	84,5	39,5	5	133	4	180

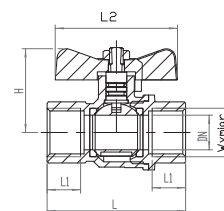

[730-120-10]

Kurek kulowy do gazu nakrętno-nakrętny z motylkiem
 Valve for gas installation female-female with wing nut
 Шаровой кран наружн. – наружн. с бабочкой
 Gaskugelhahn zum Außengewinde/Außengewinde mit Falter

indeks	wymiar	D	L	L1	L2	H	PN	waga [g]	opakow. jednost.	opakow. zbiorcze
[730-120-10]	Rp 3/8"	10	52	13,5	55	33	5	175	1	180

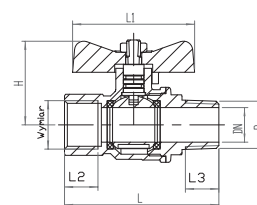

[730-220-15]

Kurek kulowy do gazu nakrętno-wkrętny z motylkiem
 Valve for gas installation female-male with wing nut
 Шаровой кран наружн. – внутр. с бабочкой
 Gaskugelhahn zum Innengewinden/ Außengewinde mit Falter

indeks	wymiar	D	L	L1	L2	H	PN	waga [g]	opakow. jednost.	opakow. zbiorcze
[730-220-15]	Rp 1/2"	15	67	55	14,5	37	5	202	2	90

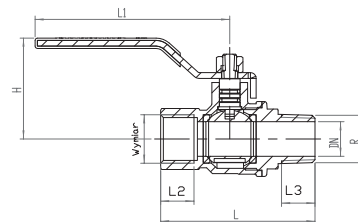

[730-210-15]

Kurek kulowy do gazu nakrętno-wkrętny z dźwignią
 Valve for gas installation female-male with lever
 Шаровой кран наружн. – внутр. с рычагом
 Gaskugelhahn mit Hebel
 Außengewinde/Innenengewinde

indeks	wymiar	D	L	L1	L2/L3	H	PN	waga [g]	opakow. jednost.	opakow. zbiorcze
[730-210-15]	Rp 1/2"	15	67	84,5	14,5	44	5	222	2	90

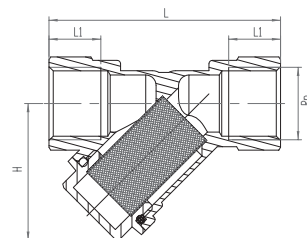

[740-000-15]

Filtr skośny do gazu
 Wye strainer for gas installation
 Угловой фильтр для газа
 Gasfilter

indeks	wymiar	L	L1	H	PN	waga [g]	opakow. jednost.	opakow. zbiorcze
[740-000-15]	Rp 1/2"	67	15	39,5	5	145	16	192



przyłącza elastyczne do gazu

valves and connectors for gas



Warunkiem bezpiecznego działania instalacji gazowej jest zastosowanie materiałów najwyższej jakości oraz jej prawidłowe wykonanie potwierdzone odbiorem zakładu gazowego. Zastosowanie w instalacji przyłącza gazowego stwarza możliwość sprawnego podłączenia urządzeń gazowych do instalacji – między innymi kuchenki gazowej. Elastyczny przewód gazowy posiada wewnętrzną rurę ze stali kwasoodpornej w oplocie stalowym ze stali nierdzewnej.

The requirements for the safe operation of gas installation is using top quality materials and proper workmanship confirmed by the gas department acceptance certificate. Application of a gas connector in the installation gives conditions for easy connection of gas devices to the installation, for instance, a gas cooker. Flexible gas pipe has an inner pipe made of acid-resistant steel in a stainless steel sleeve.



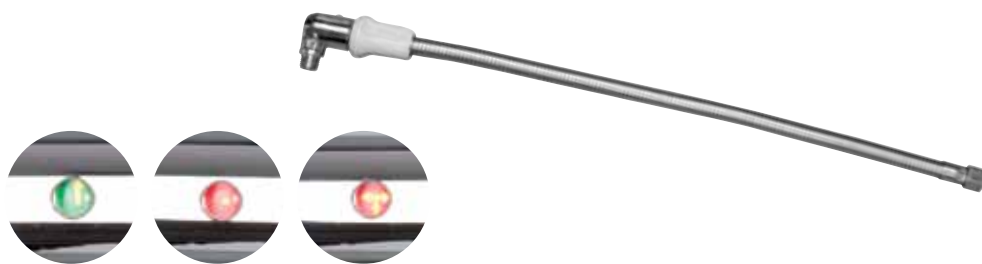

[647-050-11]

Szybkozłącze do gazu
Fast connectors for gas
Гибкие подводки для газа
Gas - Verbindungsstück

Indeks	Wymiar	Ilość w op.zb. [szt.]	EAN
[647-050-11]	1/2" - L50	10	5907571640114
[647-075-11]	1/2" - L75	10	5907571640121
[647-100-11]	1/2" - L100	10	5907571640138
[647-125-11]	1/2" - L125	10	5907571640145
[647-150-11]	1/2" - L150	5	5907571640152



[648-050-11]

Przyłącze elastyczne do gazu
Flexible connectors for gas
Гибкие подводки для газа
Gasanschluss (elastisch)

Indeks	Wymiar	Ilość w op.zb. [szt.]	EAN
[648-050-11]	1/2" - L50	10	5907571640053
[648-075-11]	1/2" - L75	10	5907571640060
[648-100-11]	1/2" - L100	10	5907571640077
[648-125-11]	1/2" - L125	10	5907571640084
[648-150-11]	1/2" - L150	5	5907571640091

Armatura sanitarna



Armatura wodna i gazowa



Grzejniki i armatura
centralnego ogrzewania



- Grzejniki aluminiowe 124
- Armatura centralnego ogrzewania 127
- Elementy złączne 130



s. 120 – 133







grzejniki aluminiowe

radiators



Grzejnik – ciepły element naszego mieszkania – nieoceniony zimą, uśpiony latem. Wykonany jest z aluminium najwyższej jakości, w trakcie produkcji poddawany wielokrotnie procesowi kontroli. Od środka zabezpieczony w procesie elektroforezy specjalną powłoką zapobiegającą korozji międzykrystalicznej, dzięki czemu możliwa jest jego współpraca z instalacją miedzianą. Oferowane parametry pracy gwarantują jego najwyższą skuteczność.

Radiator – warm element of ones home - invaluable in winter, dormant in the summer. Made of top quality aluminium, several times checked by quality control during the manufacture process. The interior is protected with a special coating during the process of electrophoresis, against intercrystalline corrosion, which enables work in copper installations. The parameters work offered, guarantee its top efficiency.



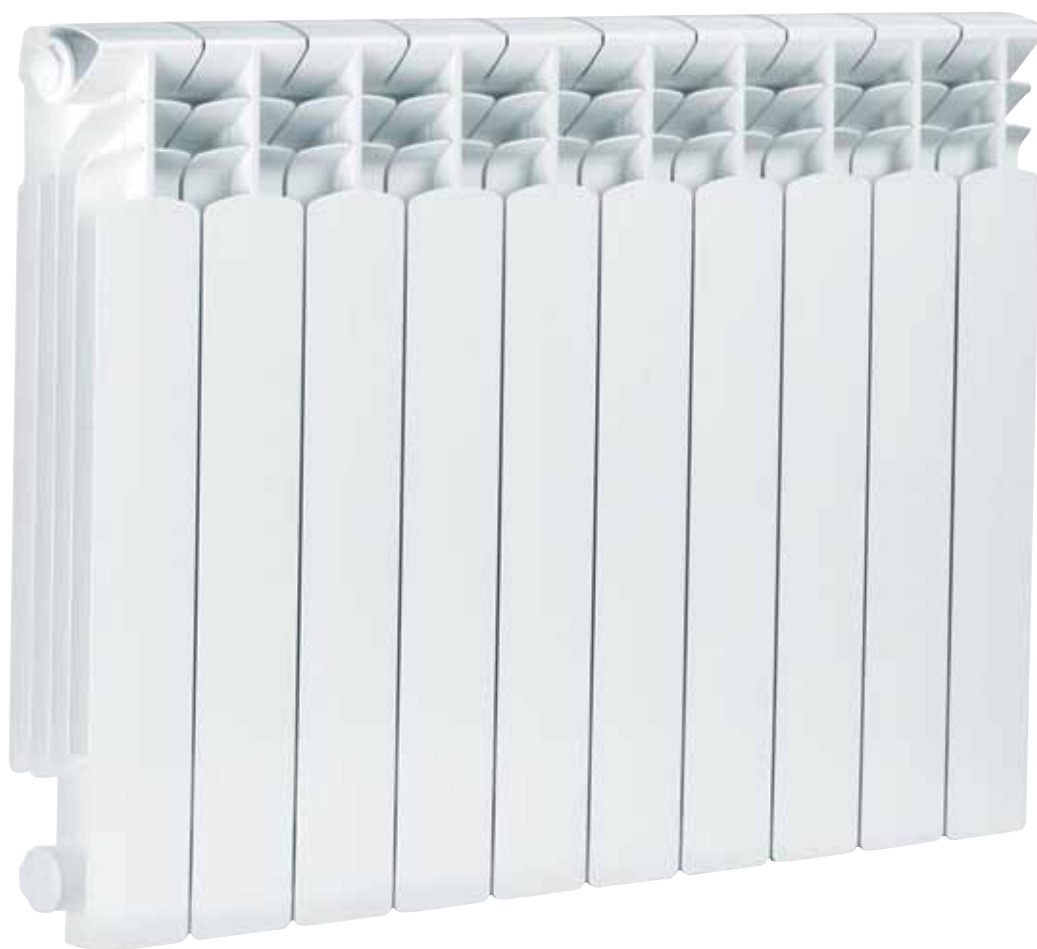

[789-100-44]

Grzejnik aluminiowy G 500 F
 Aluminium radiator G 500 F
 Алюминиевый радиатор
 Aluheizkörper

Do grzejników oferujemy:

- komplet wsporników,
- korki, złączki.

Grzejniki malowane są wysokiej jakości lakierem proszkowym koloru białego.

Radiators are provided with:

- a set of support brackets,
- plugs, connectors.

The radiators are protected using a high quality white powder coating process.

DANE TECHNICZNE G 500 F / G 500 F TECHNICAL DATA:

Całkowita wys. członu / Overall unit height	573 [mm]
Wysokość montażowa / Assembly height	500 [mm]
Całkowita szerokość / Overall width	804 [mm]
Głębokość członu / Unit depth	90 [mm]
Objętość wody w członie / Water capacity per unit	0,3 [dm ³]
Masa 1 członu / Weight of a single unit	1,5 [kg]
Temperatura robocza do / Maximum operating temperature	95 [°C]
Ciśnienie robocze do / Maximum operating pressure	1,6 [MPa]
Moc grzewcza 1 członu dla $\Delta t=50^{\circ}\text{C}$ / Heating power rating of a single unit for $\Delta t=50^{\circ}\text{C}$	112 [W]
Moc grzewcza 1 członu dla $\Delta t=60^{\circ}\text{C}$ / Heating power rating of a single unit for $\Delta t=60^{\circ}\text{C}$	141 [W]

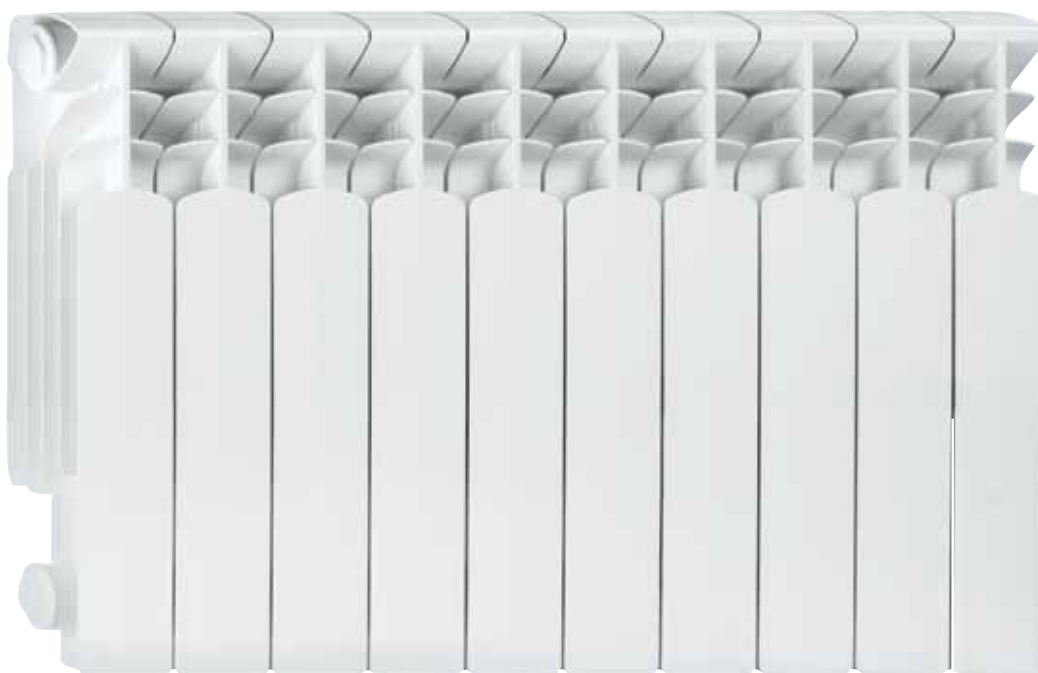

[790-100-44]

Grzejnik aluminiowy G 350 F
 Aluminium radiator G 350 F
 Алюминиевый радиатор
 Aluheizkörper

Do grzejników oferujemy:

- komplet wsporników,
- korki, złączki.

Grzejniki malowane są wysokiej jakości lakierem proszkowym koloru białego.

Radiators are provided with:

- a set of support brackets,
- plugs, connectors.

The radiators are protected using a high quality white powder coating process.

DANE TECHNICZNE G 350 F / G 350 F TECHNICAL DATA:

Całkowita wys. członu / Overall unit height	423 [mm]
Wysokość montażowa / Assembly height	350 [mm]
Całkowita szerokość / Overall width	805 [mm]
Głębokość członu / Unit depth	90 [mm]
Objętość wody w członie / Water capacity per unit	0,27 [dm ³]
Masa 1 członu / Weight of a single unit	1,0 [kg]
Temperatura robocza do / Maximum operating temperature	95 [°C]
Ciśnienie robocze do / Maximum operating pressure	1,6 [MPa]
Moc grzewcza 1 członu dla $\Delta t=50^{\circ}\text{C}$ / Heating power rating of a single unit for $\Delta t=50^{\circ}\text{C}$	87,3 [W]

armatura centralnego ogrzewania



central heating fixtures



Armatura grzewcza stanowi niezbędne wyposażenie grzejników pracujących w systemie centralnego ogrzewania. Dzięki niej możemy m. in. precyzyjnie regulować temperaturę w pomieszczeniu co gwarantuje komfort przebywania w nim oraz przyczynia się do ekonomicznego wykorzystania energii cieplnej. Zawory grzejnikowe pozwalają na konserwację lub wymianę grzejników bez konieczności wyłączenia pracującej instalacji.

Heating fixtures are the necessary equipment for heaters working in the central heating system. It helps precise room temperature regulation which assures comfort and economic energy usage. Heater valves allow maintenance or heaters replacement without stopping the installation operating.

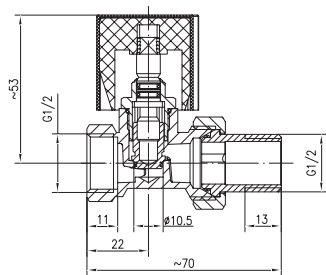

[750-060-15]

Zawór grzejnikowy prosty, mosiężny
Brass straight-run radiator valve
Вентиль для радиатора, прямой
Gerades Heizkörperventil aus Messing

indeks	wymiar D	R	H	L	opakow. jednost.	opakow. zbiorcze
[750-060-15]	1/2"	1/2"	90	90	10	120

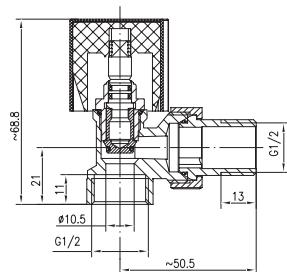

[750-160-15]

Zawór grzejnikowy kątowy, mosiężny
Brass angle radiator valve
Вентиль для радиатора, угловой
Winkelheizkörperventil aus Messing

indeks	wymiar D	R	H	L	opakow. jednost.	opakow. zbiorcze
[750-160-15]	1/2"	1/2"	105	70	5	80

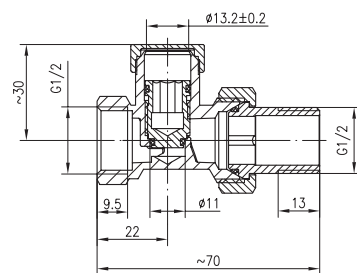

[751-000-07]

Zawór odcinający prosty, mosiężny
Brass straight-run cut-off valve
Вентиль запорный прямой, латунный
Gerades Absperrventil aus Messing

indeks	wymiar D	R	H	L	opakow. jednost.	opakow. zbiorcze
[751-000-07]	1/2"	1/2"	76	27	10	120

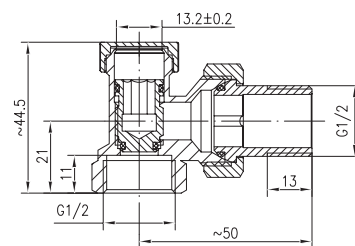

[751-100-07]

Zawór odcinający kątowy, mosiężny
 Brass angle cut-off valve
 Вентиль запорный угловой, латунный
 Winkelabsperventil aus Messing

indeks	wymiar D	R	H	L	opakow. jednost.	opakow. zbiorcze
[751-100-07]	1/2"	1/2"	44,5	54	10	120

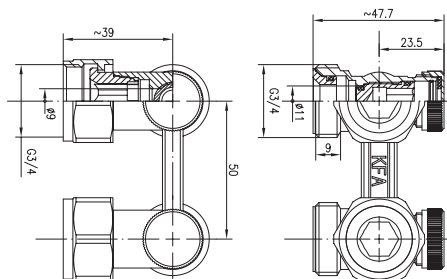

[760-101-07]

Zespół przyłączeniowy grzejnikowy kątowy + tulejki przyłączeniowe
 Connection angle with radiator sleeves
 Соединительный комплект для радиатора угловой со втулками

indeks	wymiar	L	L1	PN	Waga [g]	opakow. jednost.	opakow. zbiorcze
[760-101-07]	3/4"	50	63,5	10	371	5	40

Nowość

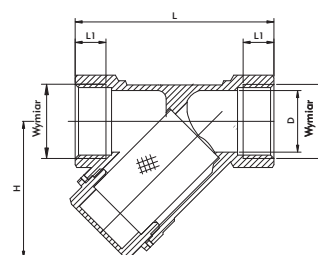

[720-000-15]

Filtr skośny do C.O.
 Y filter valve
 Угловой фильтр для центрального отопления
 Sedimentfilter für ZH

indeks	wymiar	D	H	L	L1	opakow. jednost.	opakow. zbiorcze
[720-000-15]	1/2"	16	39	53	9	40	160



elementy złączne

fasteners



To najprostsze, ale zarazem bardzo ważne elementy domowej sieci wodnej oraz centralnego ogrzewania. Bez nich budowa sieci instalacyjnej nie byłaby możliwa. Służą do łączenia różnych elementów instalacji zapewniając jej prawidłową pracę.

Most simple but very important elements of the house water system as well as central heating system. Building the installation system wouldn't be possible without fasteners. It is also designed for joining various elements in the installation, providing its correct operation.

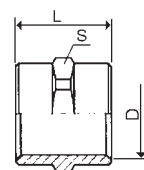

[944-720-10]

Złączka nakrętna równoprzelotowa (mufta)

Female straight tee coupling (outer sleeve)

Муфта с внутренней резьбой полнопроходная

Gleichdurchgangaufdrehmuffe

indeks	wymiar D	L	S	opakow. jednost.	opakow. zbiorcze
[944-720-10]	3/8"	24	22	1	540

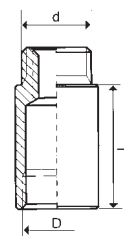

[170-200-98]

Przedłużacz

Lengthening pipe

Удлинитель

Verlängerungskabel

indeks	wymiar D	d	L	opakow. jednost.	opakow. zbiorcze
[170-200-98]	1/2"	1/2"	10	20	480

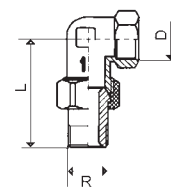

[814-012-10]

Złączka grzejnikowa kolankowa mosiężna (śrubunek)

Brass radiator elbow coupling (union)

Муфта для радиатора коленчатая («УГОЛЬНИК»), латунная

(соединительная муфта)

Bogenheizkörpermuffe aus Messing

(Verschraubung)

indeks	wymiar D	R	L	opakow. jednost.	opakow. zbiorcze
[814-012-10]	3/8"	3/8"	50	1	10

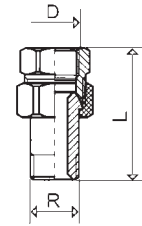

[814-010-10]

Złączka grzejnikowa prosta mosiężna (śrubunek)

Brass radiator straight coupling (union)
Муфта для радиатора прямая, латунная (соединительная муфта)
Gerade Heizkörpermuffe aus Messing (Verschraubung)

indeks	wymiar D	R	L	opakow. jednost.	opakow. zbiorcze
[814-010-10]	3/8"	3/8"	49	10	240

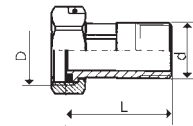

[814-020-15]

Łącznik do wodomierza z nakrętką (półśrubunek)

Fastener for water meter with nut (half union)
Фитинг для водомера с гайкой (полусоединительная муфта)
Verbindungsstück für Wasserzähler mit Mutter (Halbverschraubung)

indeks	wymiar D	d	L	opakow. jednost.	opakow. zbiorcze
[814-020-15]	3/4"	1/2"	40,5	2	192

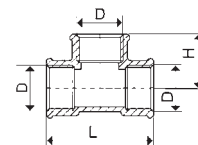

[943-700-15]

Trójnik nakrętny

Female T-connection
Тройник с внутренней резьбой
Dreiwegestück zum Aufdrehen

indeks	wymiar D	L	H	opakow. jednost.	opakow. zbiorcze
[943-700-15]	1/2"	50	25	15	180